



**SAM**<sup>®</sup>  
HOME OF MDF MOULDINGS

**PRODUCT  
CATALOGUE**

ISSUE 1

[SAMONLINE.CO.UK](http://SAMONLINE.CO.UK)



## Contact us

If you need more information or technical support, we are here to help:

T: +44 (0)28 9442 8288  
E: team@samonline.co.uk  
W: samonline.co.uk

**INVESTORS IN PEOPLE™**  
We invest in people Gold



The mark of responsible forestry  
FSC® C009081





# SAM<sup>®</sup>

HOME OF MDF MOULDINGS

## STOCK LISTING

Over 200 profiles available  
ISSUE 1

[SAMONLINE.CO.UK](http://SAMONLINE.CO.UK)

# SAM<sup>®</sup>STOCK

**Fast track delivery –  
over 200 profiles always available.**

SAM has created an extensive stock range based on customer needs and our knowledge of the market.

When you order SAM Stock products, you can be confident they will always be available and will be delivered to you quickly.

We understand time is of the essence, which is why we have included our full stock range in this listing. For our extended range of products please see the main catalogue (QR code on back page).



Skirting & Architrave



## Skirting & Architrave

### SAM23

Pencil Round One Edge

Radius: 6mm

THICKNESS (MM)	WIDTH (MM)	LENGTH (M)	FINISH	FULL PACK	TRADE PACK
14.5	44	2.1	Primed	330	110
14.5	44	4.2	Primed	330	110
14.5	44	4.2	Fully finished (SAM Zero)	352	88
14.5	69	4.2	Primed	252	84
14.5	94	4.2	Primed	220	55
14.5	94	4.2	Fully finished (SAM Zero)	220	55
14.5	119	4.2	Primed	180	72
18	44	4.2	Primed	330	110
18	69	4.2	Primed	252	84
18	94	4.2	Primed	220	55
18	119	4.2	Primed	180	36
18	144	4.2	Primed	140	28
12	94	5.49	Primed	264	132
14.5	44	5.49	Primed	330	110
14.5	57	5.49	Primed	324	108
14.5	69	5.49	Primed	252	84
14.5	94	5.49	Primed	220	55
14.5	119	5.49	Primed	180	72
14.5	144	5.49	Primed	140	56
18	44	5.49	Primed	330	110
18	57	5.49	Primed	324	108
18	69	5.49	Primed	252	84
18	94	5.49	Primed	220	55
18	119	5.49	Primed	180	36
18	144	5.49	Primed	140	28



### SAM24

Pencil Round Two Edge

Radius: 6mm

THICKNESS (MM)	WIDTH (MM)	LENGTH (M)	FINISH	FULL PACK	TRADE PACK
14.5	44	4.2	Primed	330	110
12	69	5.49	Primed	252	84
14.5	69	5.49	Primed	252	84
18	57	5.49	Primed	324	108

### SAM01

Square Edge



THICKNESS (MM)	WIDTH (MM)	LENGTH (M)	FINISH	FULL PACK	TRADE PACK
14.5	94	4.2	Primed	220	55
14.5	119	4.2	Primed	180	72
12	97	5.49	Primed	264	132
14.5	94	5.49	Primed	220	55
14.5	100	5.49	Primed	200	100
14.5	119	5.49	Primed	180	72
14.5	144	5.49	Primed	140	56
18	44	5.49	Primed	330	110
18	69	5.49	Primed	252	84
18	94	5.49	Primed	220	55
18	100	5.49	Primed	200	100
18	119	5.49	Primed	180	36
18	144	5.49	Primed	140	28

### SAM04

Square Edge  
Radius: 1.5mm



THICKNESS (MM)	WIDTH (MM)	LENGTH (M)	FINISH	FULL PACK	TRADE PACK
18	69	2.1	Primed	280	140
18	94	2.4	Primed	220	55
18	44	4.2	Primed	330	110
18	69	4.2	Primed	252	84
18	94	4.2	Primed	220	55
18	119	4.2	Primed	180	36
18	144	4.2	Primed	140	28
12	32	5.49	Primed	640	160
12	97	5.49	Primed	264	132
14.5	69	5.49	Primed	252	84
14.5	94	5.49	Primed	220	55
18	44	5.49	Primed	330	110
18	69	5.49	Primed	252	84

### SAM09

Torus  
Moulded width: 32mm



THICKNESS (MM)	WIDTH (MM)	LENGTH (M)	FINISH	FULL PACK	TRADE PACK
18	69	2.1	Primed	280	140
14.5	94	4.2	Primed	220	55
18	69	4.2	Primed	252	84
18	119	4.2	Primed	180	36
18	144	4.2	Primed	140	28
18	169	4.2	Primed	72	36
14.5	57	5.49	Primed	324	108
14.5	69	5.49	Primed	252	84
14.5	94	5.49	Primed	220	55
14.5	119	5.49	Primed	180	72
14.5	194	5.49	Primed	60	30
18	69	5.49	Primed	252	84
18	119	5.49	Primed	180	36
18	144	5.49	Primed	140	28

### SAM3166

Torus  
Moulded width: 33mm



THICKNESS (MM)	WIDTH (MM)	LENGTH (M)	FINISH	FULL PACK	TRADE PACK
18	69	2.1	Fully finished (SAM Zero)	280	140
18	119	4.2	Fully finished (SAM Zero)	180	36
18	144	4.2	Fully finished (SAM Zero)	140	28
18	169	4.2	Fully finished (SAM Zero)	72	36

**SAM93**

Ogee

Moulded width: 45mm

THICKNESS (MM)	WIDTH (MM)	LENGTH (M)	FINISH	FULL PACK	TRADE PACK
18	69	2.1	Primed	280	140
18	69	4.2	Primed	252	84
18	119	4.2	Primed	180	36
18	144	4.2	Primed	140	28
18	169	4.2	Primed	72	36
14.5	69	5.49	Primed	252	84
14.5	94	5.49	Primed	220	55
14.5	144	5.49	Primed	140	56
18	69	5.49	Primed	252	84
18	94	5.49	Primed	220	55
18	119	5.49	Primed	180	36
18	144	5.49	Primed	140	28
18	169	5.49	Primed	72	36

**SAM90**

Ogee

Moulded width: 37mm

THICKNESS (MM)	WIDTH (MM)	LENGTH (M)	FINISH	FULL PACK	TRADE PACK
18	69	2.1	Fully finished (SAM Zero)	280	140
18	144	4.2	Fully finished (SAM Zero)	140	28
18	169	4.2	Fully finished (SAM Zero)	72	36

**SAM15**

Ogee

Moulded width: 42mm

THICKNESS (MM)	WIDTH (MM)	LENGTH (M)	FINISH	FULL PACK	TRADE PACK
14.5	69	4.2	Primed	252	84
14.5	94	4.2	Primed	220	55
14.5	119	4.2	Primed	180	72
14.5	144	4.2	Primed	140	56

**SAM97**

Ogee

Moulded width: 26mm

THICKNESS (MM)	WIDTH (MM)	LENGTH (M)	FINISH	FULL PACK	TRADE PACK
14.5	144	5.49	Primed	140	56

**SAM98**

Ogee &amp; Bead

Moulded width: 26mm / Bead width: 14mm

THICKNESS (MM)	WIDTH (MM)	LENGTH (M)	FINISH	FULL PACK	TRADE PACK
14.5	69	5.49	Primed	252	84

**SAM22**

Chamfer &amp; Round

Chamfer width: 32mm

THICKNESS (MM)	WIDTH (MM)	LENGTH (M)	FINISH	FULL PACK	TRADE PACK
14.5	44	4.2	Primed	330	110
14.5	69	4.2	Primed	252	84
14.5	94	4.2	Primed	220	55
14.5	119	4.2	Primed	180	72
18	69	4.2	Primed	252	84
18	119	4.2	Primed	180	36
18	144	4.2	Primed	140	28
14.5	69	5.49	Primed	252	84
14.5	94	5.49	Primed	220	55
14.5	119	5.49	Primed	180	72
14.5	144	5.49	Primed	140	56
18	69	5.49	Primed	252	84
18	94	5.49	Primed	220	55
18	119	5.49	Primed	180	36
18	144	5.49	Primed	140	28
18	169	5.49	Primed	72	36

**SAM26**

Chamfer &amp; Round

Chamfer width: 38mm

THICKNESS (MM)	WIDTH (MM)	LENGTH (M)	FINISH	FULL PACK	TRADE PACK
18	69	5.49	Primed	252	84
18	94	5.49	Primed	220	55
18	119	5.49	Primed	180	36
18	144	5.49	Primed	140	28

**SAM1959**

Chamfer &amp; Round

Moulded width: 23mm

THICKNESS (MM)	WIDTH (MM)	LENGTH (M)	FINISH	FULL PACK	TRADE PACK
18	69	2.1	Fully finished (SAM Zero)	280	140
18	144	4.2	Fully finished (SAM Zero)	140	28
18	169	4.2	Fully finished (SAM Zero)	72	36

**SAM5061**

Chamfered

Chamfer dimensions (mm): 6 x 6

THICKNESS (MM)	WIDTH (MM)	LENGTH (M)	FINISH	FULL PACK	TRADE PACK
18	69	4.2	Primed	252	84
18	94	4.2	Primed	220	55
18	119	4.2	Primed	180	36

**SAM5062**

Chamfered

Chamfer dimensions (mm): 10 x 10

THICKNESS (MM)	WIDTH (MM)	LENGTH (M)	FINISH	FULL PACK	TRADE PACK
18	69	4.2	Primed	252	84
18	94	4.2	Primed	220	55
18	119	4.2	Primed	180	36

**SAM5059**

Single Groove

Groove dimensions (mm): 5 x 5 (20mm from edge)

THICKNESS (MM)	WIDTH (MM)	LENGTH (M)	FINISH	FULL PACK	TRADE PACK
18	69	4.2	Primed	252	84
18	119	4.2	Primed	180	36
18	144	4.2	Primed	140	28

**SAM5060**

Single Groove

Groove dimensions (mm): 15 x 5 (20 mm from edge)

THICKNESS (MM)	WIDTH (MM)	LENGTH (M)	FINISH	FULL PACK	TRADE PACK
18	69	4.2	Primed	252	84
18	119	4.2	Primed	180	36
18	144	4.2	Primed	140	28

**SAM27**

Ovolo

Moulded width: 35mm

THICKNESS (MM)	WIDTH (MM)	LENGTH (M)	FINISH	FULL PACK	TRADE PACK
14.5	57	4.2	Primed	324	108
14.5	94	4.2	Primed	220	55
14.5	119	4.2	Primed	180	72
14.5	144	4.2	Primed	140	56
18	57	4.2	Primed	324	108
18	69	4.2	Primed	252	84
18	119	4.2	Primed	180	36
18	69	4.2	Fully finished (SAM Zero)	252	84
18	119	4.2	Fully finished (SAM Zero)	180	36
18	144	4.2	Fully finished (SAM Zero)	140	28
18	169	4.2	Fully finished (SAM Zero)	72	36
14.5	57	5.49	Primed	324	108
14.5	94	5.49	Primed	220	55
14.5	119	5.49	Primed	180	72

**SAM20**

Bullnose

Radius: 10mm

THICKNESS (MM)	WIDTH (MM)	LENGTH (M)	FINISH	FULL PACK	TRADE PACK
14.5	44	2.1	Primed	330	110
14.5	69	4.2	Primed	252	84
14.5	94	4.2	Primed	220	55

**SAM29**

Bullnose

Radius: 20mm

THICKNESS (MM)	WIDTH (MM)	LENGTH (M)	FINISH	FULL PACK	TRADE PACK
14.5	44	2.1	Primed	330	110
14.5	44	4.2	Primed	330	110
14.5	94	4.2	Primed	220	55
18	69	4.2	Primed	252	84
18	119	4.2	Primed	180	36



**SAM1855**

Bullnose

Radius: 17mm

THICKNESS (MM)	WIDTH (MM)	LENGTH (M)	FINISH	FULL PACK	TRADE PACK
18	69	2.1	Fully finished (SAM Zero)	280	140
18	144	4.2	Fully finished (SAM Zero)	140	28
18	169	4.2	Fully finished (SAM Zero)	72	36

**SAM4288**

Round &amp; V-Groove

Radius: 2mm / V-Groove dimensions (mm): (w)3 x (d)3

THICKNESS (MM)	WIDTH (MM)	LENGTH (M)	FINISH	FULL PACK	TRADE PACK
14.5	69	4.2	Primed	252	84
14.5	119	4.2	Primed	180	72
18	69	4.2	Primed	252	84
18	144	4.2	Primed	140	28

**SAM2975**

Chamfer &amp; Single V-Groove

Chamfer dimensions (mm): 5 x 5 / V-Groove dimensions (mm): (w)6 x (d)3

SAM2984 is the skirting board

THICKNESS (MM)	WIDTH (MM)	LENGTH (M)	FINISH	FULL PACK	TRADE PACK
14.5	94	5.49	Primed	220	55
18	69	5.49	Primed	252	84

**SAM2984**

Chamfer &amp; Double V-Groove

Chamfer dimensions (mm): 5 x 5 / V-Groove dimensions (mm): (w)6 x (d)3

SAM2975 is the architrave

THICKNESS (MM)	WIDTH (MM)	LENGTH (M)	FINISH	FULL PACK	TRADE PACK
14.5	119	5.49	Primed	180	72

**SAM28**

Lambs Tongue

Moulded width: 34mm

THICKNESS (MM)	WIDTH (MM)	LENGTH (M)	FINISH	FULL PACK	TRADE PACK
18	69	4.2	Primed	252	84
18	119	4.2	Primed	180	36
18	144	4.2	Primed	140	28

**SAM10**

Moulded

Moulded width: 45mm

THICKNESS (MM)	WIDTH (MM)	LENGTH (M)	FINISH	FULL PACK	TRADE PACK
18	69	5.49	Primed	252	84
18	94	5.49	Primed	220	55
18	119	5.49	Primed	180	36
18	144	5.49	Primed	140	28

**SAM5219**

Chamfer Stepped

Moulded width: 50mm

THICKNESS (MM)	WIDTH (MM)	LENGTH (M)	FINISH	FULL PACK	TRADE PACK
22	69	5.49	Primed	224	56
22	144	5.49	Primed	84	28

**SAM4887**

Edwardian

Moulded width: 51.5mm

THICKNESS (MM)	WIDTH (MM)	LENGTH (M)	FINISH	FULL PACK	TRADE PACK
18	94	5.49	Primed	220	55
18	144	5.49	Primed	140	28

**SAM3518**

Georgian

Moulded width: 48mm

THICKNESS (MM)	WIDTH (MM)	LENGTH (M)	FINISH	FULL PACK	TRADE PACK
18	94	4.4	Primed	220	55
18	144	4.2	Primed	140	28

**SAM3525**

Victorian

Moulded width: 93.5mm

THICKNESS (MM)	WIDTH (MM)	LENGTH (M)	FINISH	FULL PACK	TRADE PACK
18	100	4.2	Primed	200	100

**SAM3526**

Victorian

Moulded with: 110mm

THICKNESS (MM)	WIDTH (MM)	LENGTH (M)	FINISH	FULL PACK	TRADE PACK
18	180	4.2	Primed	60	30

**SAM502**

Hockey Stick

THICKNESS (MM)	WIDTH (MM)	LENGTH (M)	FINISH	FULL PACK	TRADE PACK
18	32	5.49	Primed	396	132

**SAM2574**

Dual Purpose: Chamfer &amp; Round (SAM22) / Pencil Round (SAM23)

Chamfer width: 32mm / Radius: 6mm

Architrave options shown in Skirting &amp; Architrave stock section

THICKNESS (MM)	WIDTH (MM)	LENGTH (M)	FINISH	FULL PACK	TRADE PACK
14.5	94	4.2	Primed	220	55
14.5	144	4.2	Primed	140	56

**SAM2285**

Dual Purpose: Chamfer &amp; Round (SAM22) / Pencil Round (SAM23)

Chamfer width: 32mm / Radius: 6mm

Architrave options shown in Skirting &amp; Architrave stock section

THICKNESS (MM)	WIDTH (MM)	LENGTH (M)	FINISH	FULL PACK	TRADE PACK
18	119	4.2	Primed	180	36
18	144	4.2	Primed	140	28

**SAM2156**

Dual Purpose: Torus (SAM09) / Ogee (SAM93)

Moulded width: 32mm / Moulded width: 45mm

Architrave options shown in Skirting &amp; Architrave stock section

THICKNESS (MM)	WIDTH (MM)	LENGTH (M)	FINISH	FULL PACK	TRADE PACK
18	119	4.2	Primed	180	36
18	144	4.2	Primed	140	28
18	169	4.2	Primed	72	36

**SAM5378**

Dual Purpose: Ovolo (SAM27) / Round &amp; V-Groove (SAM4288)

Moulded width: 35mm / Radius: 2mm &amp; V-Groove dimensions (mm): (w)3 x (d)3

Architrave options shown in Skirting &amp; Architrave stock section

THICKNESS (MM)	WIDTH (MM)	LENGTH (M)	FINISH	FULL PACK	TRADE PACK
14.5	119	4.2	Primed	180	36

**SAM5381**

Dual Purpose: Pencil Round (SAM23) / Ovolo (SAM27)

Radius: 6mm / Moulded width: 35mm

Architrave options shown in Skirting &amp; Architrave stock section

THICKNESS (MM)	WIDTH (MM)	LENGTH (M)	FINISH	FULL PACK	TRADE PACK
14.5	94	4.2	Primed	220	55
14.5	119	4.2	Primed	180	36

**SAM5383**

Dual Purpose: Square Edge (SAM04) / Grooved (SAM5059)

Radius: 1.5mm / Groove dimensions (mm): 5 x 5 (20mm from edge)

Architrave options shown in Skirting &amp; Architrave stock section

THICKNESS (MM)	WIDTH (MM)	LENGTH (M)	FINISH	FULL PACK	TRADE PACK
18	119	4.2	Primed	180	36
18	144	4.2	Primed	140	28

**SAM5379**

Dual Purpose: Grooved (SAM5059) / Round &amp; V-Groove (SAM4288)

Groove dimensions (mm): 5 x 5 (20mm from edge) / Radius: 2mm &amp; V-Groove dimensions (mm): (w)3 x (d)3

Architrave options shown in Skirting &amp; Architrave stock section

THICKNESS (MM)	WIDTH (MM)	LENGTH (M)	FINISH	FULL PACK	TRADE PACK
18	119	4.2	Primed	180	36
18	144	4.2	Primed	140	28

**Decorative Mouldings****SAM3031**

Cornice

THICKNESS (MM)	WIDTH (MM)	LENGTH (M)	FINISH	FULL PACK	TRADE PACK
18	115	5.49	Primed	180	36

**SAM3770**

Cornice

THICKNESS (MM)	WIDTH (MM)	LENGTH (M)	FINISH	FULL PACK	TRADE PACK
12	77	5.49	Primed	216	72

## Internal Cladding & Panelling

### SAM3012

Tongue & Groove  
TG&V

THICKNESS (MM)	WIDTH (MM)	LENGTH (M)	FINISH	FULL PACK	TRADE PACK
12	94	0.9	Fully finished (SAM Zero)	396	198
9	94	2.44	Fully finished (SAM Zero)	264	132
9	144	2.44	Fully finished (SAM Zero)	168	84

### SAM01

Square Edge

THICKNESS (MM)	WIDTH (MM)	LENGTH (M)	FINISH	FULL PACK	TRADE PACK
12	97	5.49	Primed	264	132
14.5	94	5.49	Primed	220	55

### SAM04

Square Edge  
Radius: 1.5mm

THICKNESS (MM)	WIDTH (MM)	LENGTH (M)	FINISH	FULL PACK	TRADE PACK
12	32	5.49	Primed	640	160
12	97	5.49	Primed	264	132
14.5	69	5.49	Primed	252	84
14.5	94	5.49	Primed	220	55

## Window board

### SAM50

Window board  
Bullnosed & Rebated

THICKNESS (MM)	WIDTH (MM)	LENGTH (M)	FINISH	FULL PACK	TRADE PACK
18	194	5.49	Primed	60	20
18	219	5.49	Primed	60	20
18	244	5.49	Primed	48	20

### SAM52

Window board  
Bullnosed & Rebated

THICKNESS (MM)	WIDTH (MM)	LENGTH (M)	FINISH	FULL PACK	TRADE PACK
25	194	3.66	Primed	40	20
25	219	3.66	Primed	40	10
25	244	3.66	Primed	40	12
25	269	3.66	Primed	40	12
25	294	3.66	Primed	40	12
25	194	5.49	Primed	40	20
25	219	5.49	Primed	40	10
25	244	5.49	Primed	40	12
25	269	5.49	Primed	40	12
25	294	5.49	Primed	40	12

## Door linings & stops

### SAM04

Square Edge adjustable door lining set

2 legs and adjustable head supplied with door stops to suit

Suitable for all standard door sizes

THICKNESS (MM)	WIDTH (MM)	LENGTH (M)	FINISH	FULL PACK	TRADE PACK
25	108	—	Primed	54	18
25	132	—	Primed	48	16

### SAM04

Square Edge door lining

Radius: 1.5mm

THICKNESS (MM)	WIDTH (MM)	LENGTH (M)	FINISH	FULL PACK	TRADE PACK
25	94	2.1	Primed	176	44
25	155	2.1	Primed	72	24

### SAM04

Square Edge door stop

Radius: 1.5mm

THICKNESS (MM)	WIDTH (MM)	LENGTH (M)	FINISH	FULL PACK	TRADE PACK
12	32	5.49	Primed	640	160
12	97	5.49	Primed	264	132

## SAM MDF mouldings imperial to metric conversion chart

NOMINAL IMPERIAL	SAM FINISHED SIZE METRIC
2 inches	44mm
2¼ inches	57mm
3 inches	69mm
4 inches	94mm
5 inches	119mm
6 inches	144mm
7 inches	169mm
8 inches	194mm
9 inches	219mm
10 inches	244mm
11 inches	269mm
12 inches	294mm

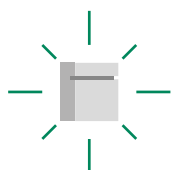

### Ordering samples

We understand that it is important for some of your customers to see a physical sample of the product before placing an order. For this reason, we keep all our stock profiles (in at least one size) in the sample store to ensure quick delivery.

You can order samples on the SAM website or by emailing [marketing@samonline.co.uk](mailto:marketing@samonline.co.uk).



### Placing an order

Once a trade account has been created for your company, you can order SAM products using a valid purchase order number.

Please send any orders to [orders@samonline.co.uk](mailto:orders@samonline.co.uk) and our internal sales team will process these as quickly as possible.

# SAM<sup>®</sup>

HOME OF MDF MOULDINGS



Scan the QR code  
to view digital copies  
of our brochures



[samonline.co.uk](http://samonline.co.uk)

# Contents

---

Home of MDF Mouldings Page 01

---

MDF at a Glance Page 03

---

SAM Cares Page 05

---

Why SAM? Page 08

---

---

SAM Mouldings Page 09

---

SAM Zero Page 10

---

SAM Wrap Page 11

---

SAM Extreme Page 12

---

---

SAM Xtra Page 13

---

SAM Bespoke Page 14

---

---

Skirting & Architrave Page 15-40

---

---

Architrave & Plinth Blocks Page 41-44

---

---

Decorative Mouldings Page 45-50

---

---

Internal Cladding & Panelling Page 51-54

---

---

Window Board Page 55-58

---

---

Door Framing Page 59-64

---

---

Stair Accessories Page 65-68

---

---

Fascia & Soffit Page 69-72

---

---

External Cladding & Panelling Page 73-76

---

---

Practical Information Page 77-83

---



## Home of MDF mouldings

Founded by Sam and Julienne McCrea in 1990, SAM is still a family run business today. For over 30 years, SAM has been trusted by the construction and home improvement industries to manufacture quality MDF mouldings that have been fitted in homes, offices, hotels and other commercial buildings across the UK, Ireland, Europe and as far afield as the United States of America.

With factories and offices in Northern Ireland and England, and continued investment into our product quality, range, availability and delivery, SAM is well placed to provide a market leading, consistent and reliable service package to customers through our personable and professional team.







**For over 30 years, SAM  
has been trusted by the  
construction and home  
improvement industries  
to manufacture quality  
MDF mouldings**



## MDF at a glance

### What is MDF?

MDF is a low wastage, engineered wood product manufactured by grinding softwood chips into fibres, binding them with synthetic resin and wax and pressing them into flat panels under high heat and pressure.

### Moisture Resistant (MR)

All SAM skirting, architrave, window board and door framing is manufactured using moisture resistant MDF, which provides good stability in damp conditions and is therefore suitable for high humidity environments such as kitchens and bathrooms.

### Benefits:



Easy to cut and install



Little wastage –  
no defects or knots



Stable yet flexible,  
so perfect for  
uneven walls



Smooth surface  
provides a great  
paint finish



Provides consistent  
quality



Available in long  
lengths



Wide range of profiles  
to choose from



Requires low  
maintenance







## SAM Cares

Climate change is one of today's biggest challenges. At SAM, we are playing an active role in reducing our carbon emissions.



**We recycle** our waste through a wood waste steam boiler and turbine, which provides electricity, heat and paint drying power to our factory.



**We generate** additional electricity through photovoltaic solar panels installed on our factory roofs.



**We source** our raw materials ethically. With our FSC® certification, you can be sure that we are working to preserve the world's forests.

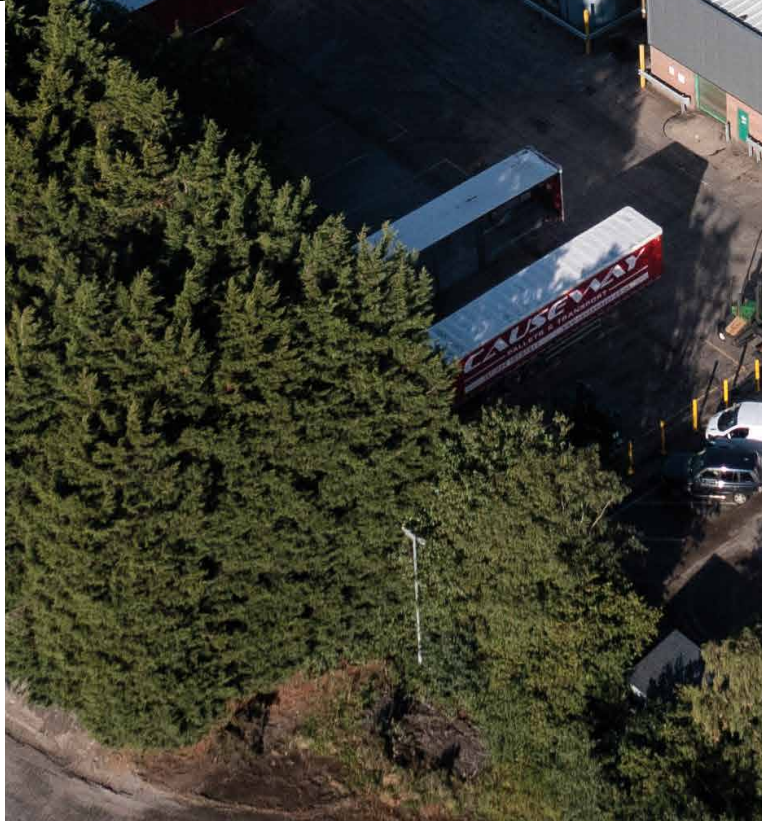

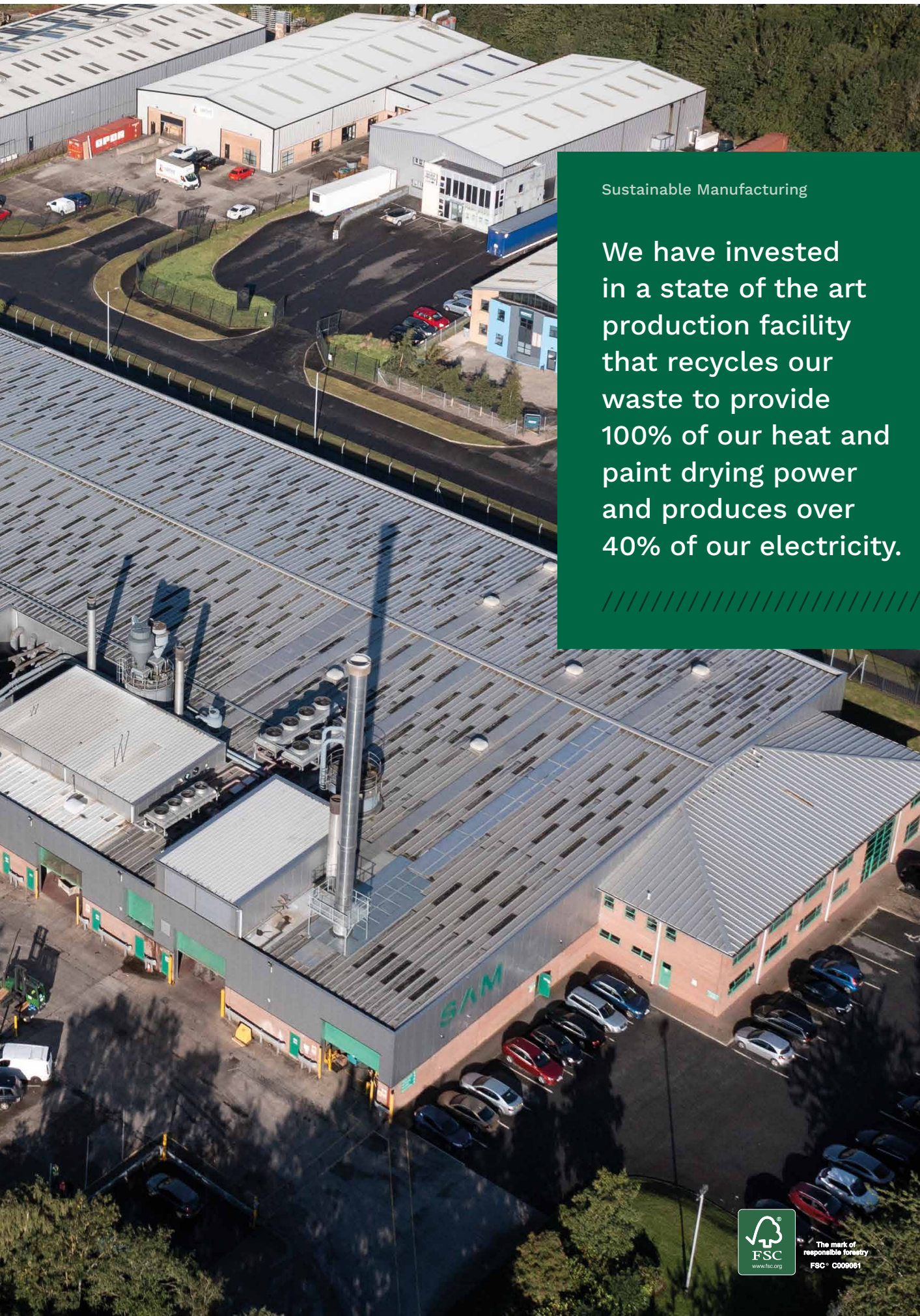

## Sustainable Manufacturing

We have invested in a state of the art production facility that recycles our waste to provide 100% of our heat and paint drying power and produces over 40% of our electricity.





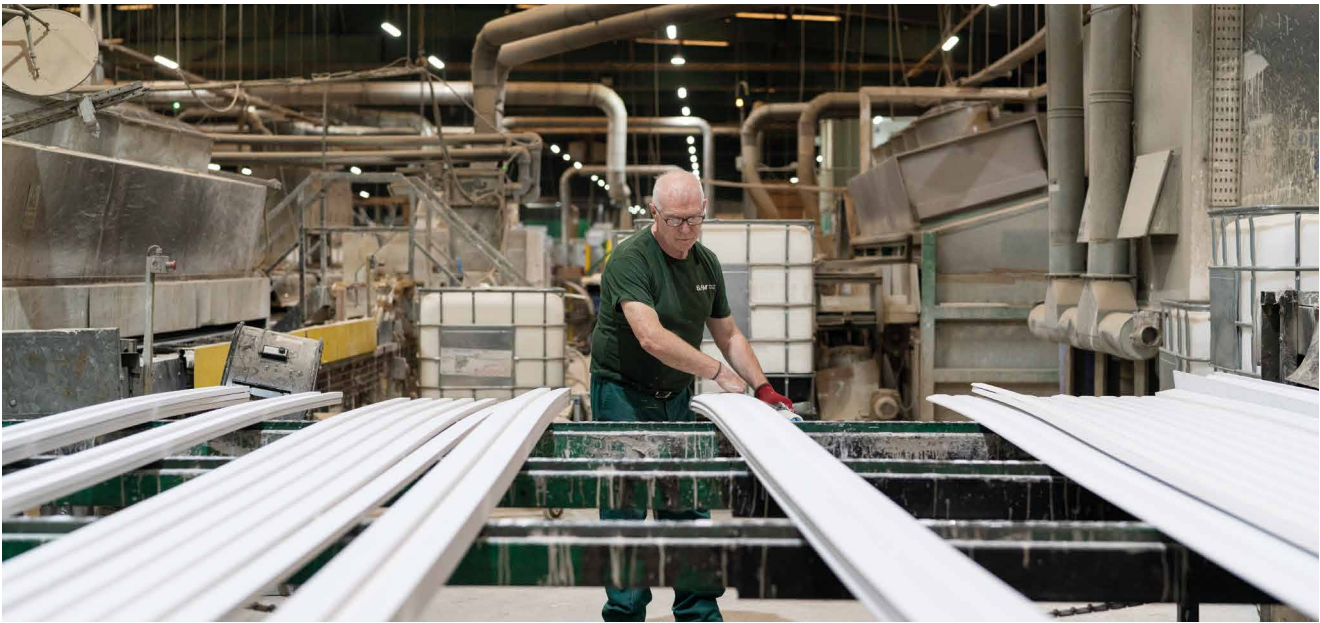

## Why SAM?

SAM is the home of MDF mouldings, trusted to provide a reliable and personal service – sustainably manufacturing and delivering the finest quality and widest range on time every time.

- Customer-first approach – we work with you to help you achieve your business goals
- Reliable – we deliver your products on time every time
- Widest range – over 6000 profiles and counting
- Consistent quality with our superior primed paint finish
- Over 200 profiles always available through our fast track stock range
- Product expertise and technical knowledge
- Sales and marketing support
- Friendly, personal service – we work with people

# SAM<sup>®</sup> MOULDINGS

With over 6000 different profiles in our product library, SAM has an unrivalled range of primed MDF mouldings in the marketplace to suit all styles and budgets including:

- Skirting
- Architrave
- Architrave & Plinth blocks
- Dado rail
- Picture rail
- Ceiling cornice
- Interior cladding
- Window board
- Door framing
- Stair accessories (unprimed)

## Main uses:

- Housing/Apartment developments
- Social housing
- Office spaces
- Hotels
- Offsite construction projects
- Park & leisure homes
- Self build projects
- Repair, maintenance & improvement (RMI)
- DIY projects

## Benefits:

- Easy to cut and install
- Resistant to warping and swelling
- Free from defects and knots
- Moisture resistant
- Low maintenance
- Smooth surfaces for painting
- Consistent quality

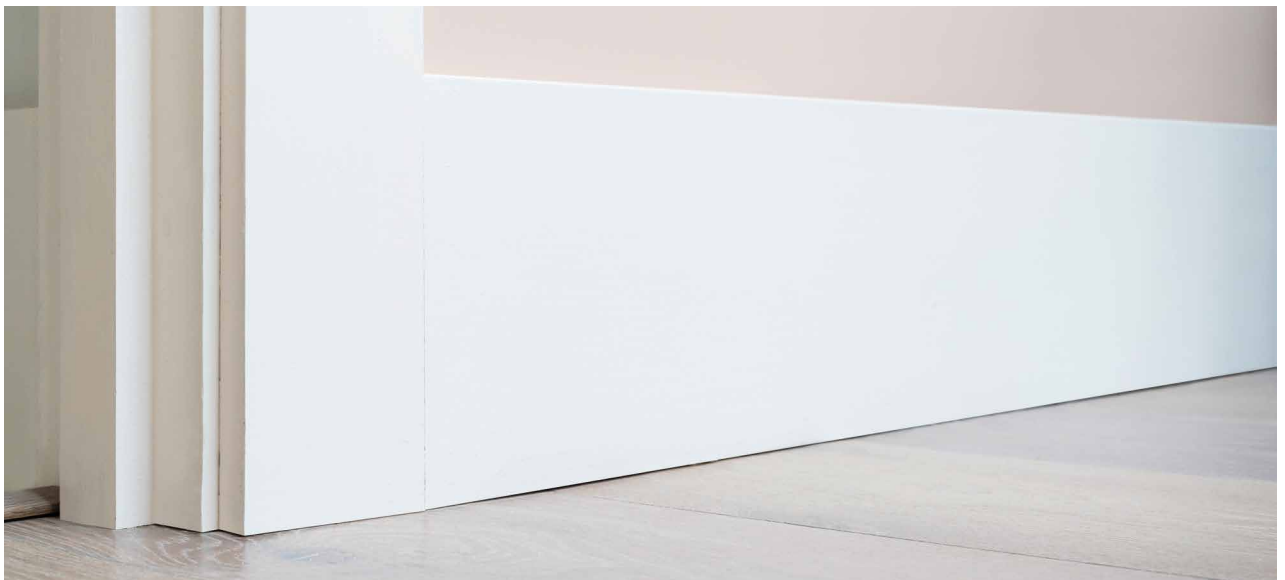
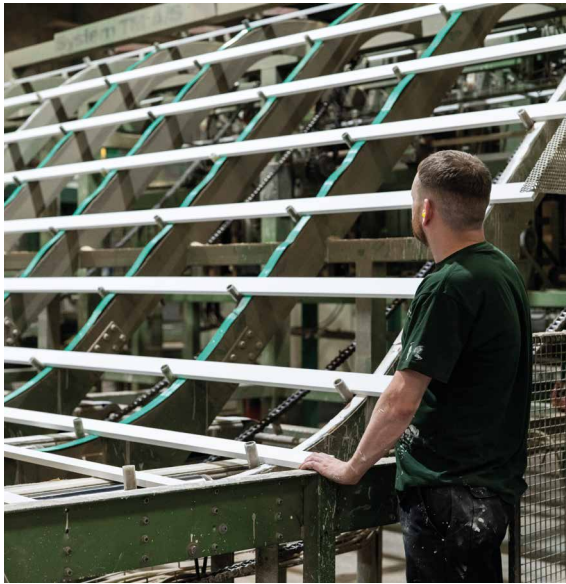



This high quality range of fully finished MDF mouldings offers a time saving alternative to primed products and is hugely popular in the offsite construction and DIY markets. Manufactured using an acrylic top coat on top of two coats of primer, it is quick and easy to install and eliminates the need for further painting, therefore reducing costs on finishing products and additional labour. The range includes:

- Skirting
- Architrave
- Interior cladding
- Window board
- Door framing

**Main uses:**

- Housing/Apartment developments
- Social housing
- Office spaces
- Hotels
- Offsite construction projects
- Park & leisure homes
- Self build projects
- Repair, maintenance & improvement (RMI)
- DIY projects

**Benefits:**

- Cost savings on labour
- Consistent product finish and quality
- Durable
- Easy to cut and install
- Resistant to warping and swelling
- Free from defects and knots
- Moisture resistant
- Low maintenance



SAM®

WRAP

SAM MDF profiles wrapped in real wood veneer provide a high quality, cost-effective alternative to solid timber. SAM PVC wrapped products offer a robust and time saving solution over primed or softwood options. The range includes:

- Skirting
- Architrave
- Decorative wall slats
- Window board
- Door framing

#### Veneer wrap finishes:\*



White Oak



Walnut



Ash



Cherry



Maple

Steamed  
Beech

#### PVC wrap finishes:\*

White  
TexturedLight  
Walnut

\*Other finishes available on request

\*\* Extensive range of paper wrap held in stock

#### Main uses:

- Housing/Apartment developments
- Social housing
- Office spaces
- Hotels
- Offsite construction projects
- Park & leisure homes
- Self build projects
- Repair, maintenance & improvement (RMI)
- DIY projects
- Door components
- Glazing beads
- Kitchen components
- Picture framing\*\*

#### Benefits:

- Match to wooden flooring or doors
- Cost effective alternative to solid wood
- Wide range of finishes available
- Consistent colours and quality
- Easy to cut and install
- Resistant to warping and swelling
- Free from defects and knots
- Moisture resistant
- Low maintenance

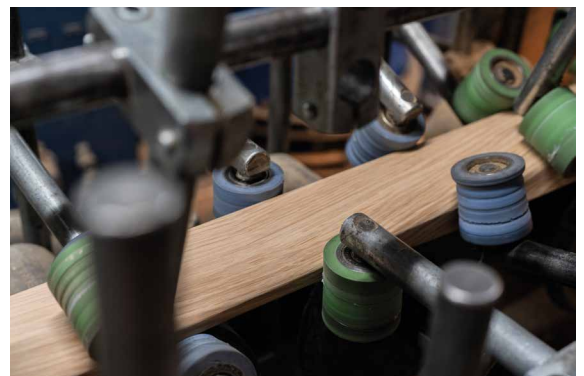

Manufactured using MEDITE TRICOYA EXTREME (MTX), this extremely durable fibreboard range offers endless possibilities for exterior applications and is available unprimed, primed or fully finished in a wide range of colours. Products offered by SAM include:

- Fascia
- Soffit
- Decorative cladding and panels

**Popular colours:\***



\*Other colours available on request



**Benefits:**

- Extended performance guarantee (50 years)
- Dimensionally stable
- Lower maintenance costs
- Ultimate durability
- Lightweight and easy to install
- Fungal resistant
- Termite resistant
- Wide range of colours available
- Cost effective solution over product lifespan

**Main uses:**

- Housing developments
- Self build projects
- Offices and hotels
- Garden rooms, beach huts & cabins
- Window components

**Technical information:**

- FSC<sup>®</sup> certified
- 50-year warranty on core material
- Paint warranty up to 10 years
- Formaldehyde Class E1
- CARB2 compliant
- Durability Class 1 under EN350-2
- BBA full assessment M2/49109

# SAM<sup>®</sup>XTRA

We can bring extra value and convenience to your customers with these additional services:

- Cross cut service – product lengths cut to a particular size to help facilitate on-site constraints for storage or movement of goods
- Mitred architrave – helps to speed up the installation process on-site
- Returned end window board – bullnosed on 3 sides so it is ready to install
- Labelling and packaging including shrink or spiral wrap

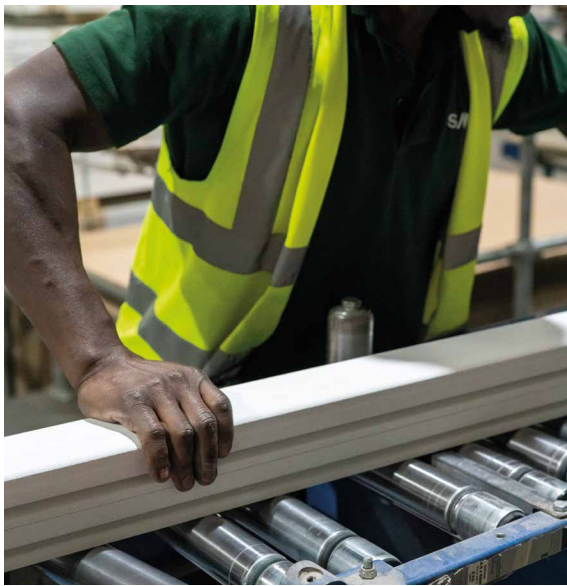

## Door frame services

- Traditional trenched door lining sets – legs pre-cut to size allowing for on-site flooring tolerance and heads trenched to suit door widths.
- Adjustable door lining sets – legs rebated to receive an adjustable head to allow for varying door widths.
- Reversible door lining sets – head trenched on both sides to allow for varying door widths
- H-frame door lining sets – grooved linings to accept tongued architrave for easy on-site installation.
- Door lining sets to include hinge and latch recessing, with or without pre-drilled pilot holes.
- Intumescent strip and ironmongery installation (supplied by customer to SAM)

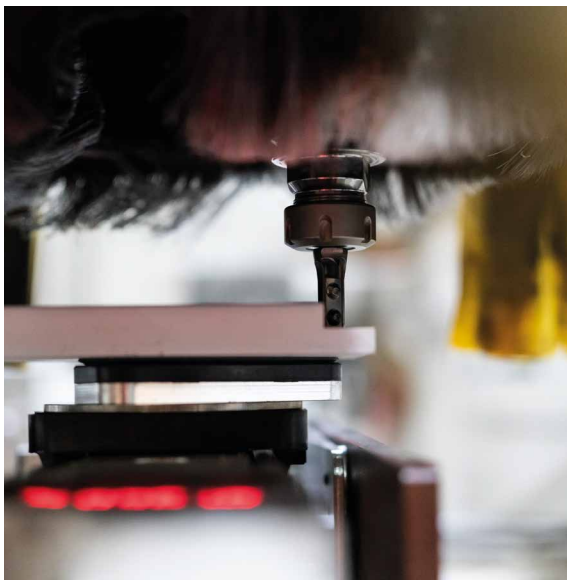

# SAM<sup>®</sup>BESPOKE

SAM has over 6000 different profiles in our product library, so we have only included variations of our most popular products and profiles in this catalogue, but we understand they may not suit every project.

If you need to match existing mouldings (for example, in period or listed properties) or if you have been presented with an image or drawing, we are here to help.

Simply email your image to [team@samonline.co.uk](mailto:team@samonline.co.uk) along with the dimensions and quantities you need. Please note, minimum order quantities apply for bespoke products.

Once our technical team has confirmed the profile, we can also provide a 3D sample to ensure you are happy with the product before it is manufactured.

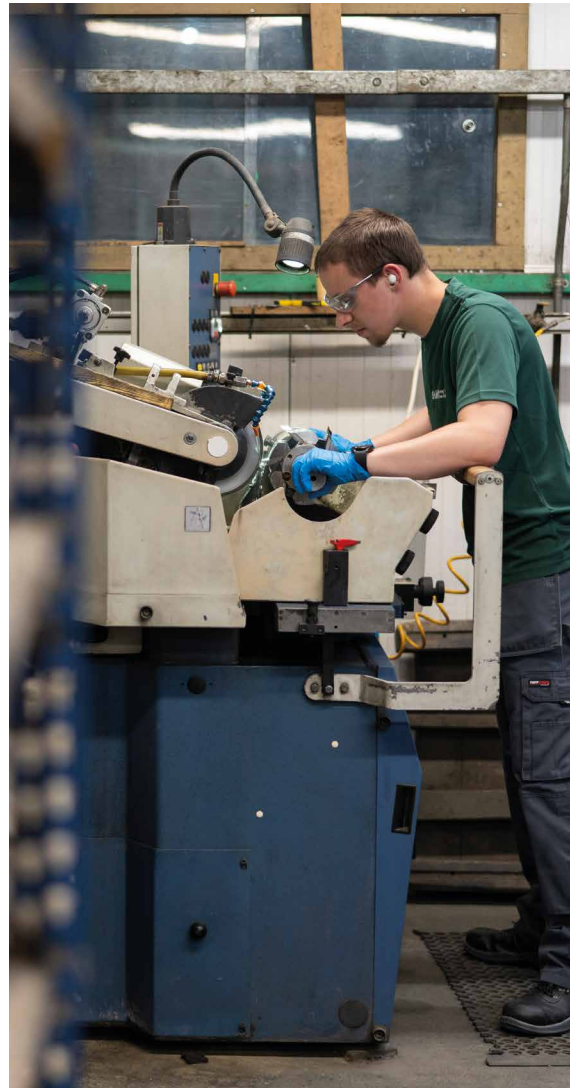
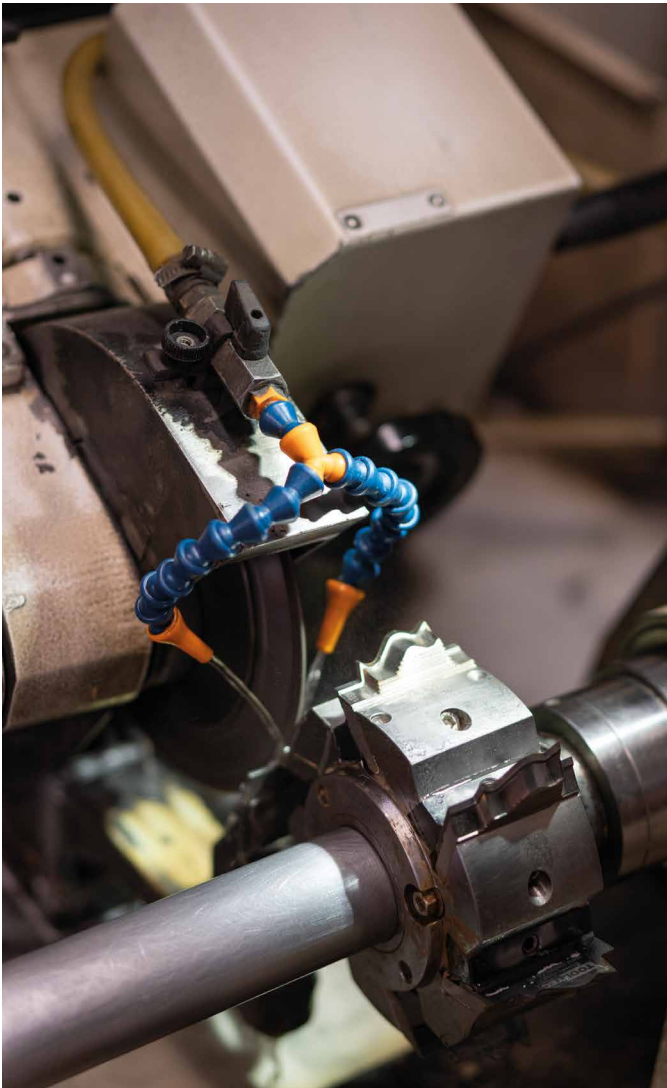



GRANDIOSA CORR  
En la que se describe con el p  
y el carácter de  
& ESCO  
de la  
CELE

LUIS  
NIÑO DE  
OSCA

DOMESTIC

The GOOD

# Skirting & Architrave

Whether you are working on a new build project or renovating a period property, you will find something to suit every style in our extensive selection of MDF skirting and architrave.

<b>Traditional</b>	<b>Page 17</b>	<b>Contemporary</b>	<b>Page 29</b>
<b>Torus</b>	<b>Page 18</b>	<b>Square Edge</b>	<b>Page 30</b>
<b>Ogee</b>	<b>Page 19</b>	<b>Pencil Round</b>	<b>Page 31</b>
<b>Stepped</b>	<b>Page 23</b>	<b>Bullnose</b>	<b>Page 32</b>
<b>Period</b>	<b>Page 25</b>	<b>Chamfer &amp; Round</b>	<b>Page 33</b>
<b>Dual Purpose</b>	<b>Page 27</b>	<b>Grooved &amp; Fluted</b>	<b>Page 35</b>











# Traditional Profiles

The preference may be simple décor or something more ornate, but whatever the style we have profiles to suit all tastes in our range of traditional MDF skirting and architrave. Why not enhance the selected architrave with a hockey stick? It looks great around doors and windows!















- Standard size
- Available on request

	<b>Torus SAM09</b> Moulded width: 32mm	<b>Torus SAM3166</b> Moulded width: 33mm
<b>SAM<sup>®</sup>STOCK</b>		
<b>Fast track available</b> (See Stock section)	Yes	Yes
<b>Thicknesses available (mm)</b>		
12	●	●
14.5	●	●
18	●	●
22	●	●
25	●	●
30	●	●
<b>Widths available (mm)</b>		
44	●	●
57	●	●
69	●	●
94	●	●
119	●	●
144	●	●
169	●	●
194	●	●
Other sizes available on request	Yes	Yes
<b>Finishes available</b>	    Unprimed Primed SAM Wrap SAM Zero	    Unprimed Primed SAM Wrap SAM Zero
<b>SAM<sup>®</sup>XTRA</b>		
Architrave can be cut to size and mitred	Yes	Yes

<b>Lengths available</b>						
Thickness (mm)	12	14.5	18	22	25	30
Length (m)	4.88, 5.49	3.66, 4.2, 4.4, 4.88, 5.49	3.66, 4.2, 4.4, 4.88, 5.49	4.4, 5.49	3.66, 4.2, 5.1, 5.49	4.2, 5.1















- Standard size
- Available on request

	<b>Ogee SAM93</b> Moulded width: 45mm	<b>Ogee SAM90</b> Moulded width: 37mm	<b>Ogee SAM15</b> Moulded width: 42mm
<b>SAM<sup>®</sup>STOCK</b>			
<b>Fast track available</b> (See Stock section)	Yes	Yes	Yes
<b>Thicknesses available (mm)</b>			
12	●	●	●
14.5	●	●	●
18	●	●	●
22	●	●	●
25	●	●	●
30	●	●	●
<b>Widths available (mm)</b>			
44	—	●	—
57	●	●	●
69	●	●	●
94	●	●	●
119	●	●	●
144	●	●	●
169	●	●	●
194	●	●	●
Other sizes available on request	Yes	Yes	Yes
<b>Finishes available</b>	   	   	 
<b>SAM<sup>®</sup>XTRA</b>			
Architrave can be cut to size and mitred	Yes	Yes	Yes

<b>Lengths available</b>						
Thickness (mm)	12	14.5	18	22	25	30
Length (m)	4.88, 5.49	3.66, 4.2, 4.4, 4.88, 5.49	3.66, 4.2, 4.4, 4.88, 5.49	4.4, 5.49	3.66, 4.2, 5.1, 5.49	4.2, 5.1



- Standard size
- Available on request

	<b>Ogee SAM97</b> Moulded width: 26mm	<b>Ogee &amp; Bead SAM98</b> Moulded width: 26mm Bead width: 14mm	<b>Ovolo SAM27</b> Moulded width: 35mm
<b>SAM<sup>®</sup>STOCK</b>			
<b>Fast track available</b> (See Stock section)	Yes	Yes	Yes
<b>Thicknesses available (mm)</b>			
12	●	●	●
14.5	●	●	●
18	●	●	●
22	●	●	●
25	●	●	●
30	●	●	●
<b>Widths available (mm)</b>			
44	●	—	●
57	●	●	●
69	●	●	●
94	●	●	●
119	●	●	●
144	●	●	●
169	●	●	●
194	●	●	●
Other sizes available on request	Yes	Yes	Yes
<b>Finishes available</b>	   	   	   
<b>SAM<sup>®</sup>XTRA</b>			
Architrave can be cut to size and mitred	Yes	Yes	Yes

<b>Lengths available</b>						
Thickness (mm)	12	14.5	18	22	25	30
Length (m)	4.88, 5.49	3.66, 4.2, 4.4, 4.88, 5.49	3.66, 4.2, 4.4, 4.88, 5.49	4.4, 5.49	3.66, 4.2, 5.1, 5.49	4.2, 5.1



- Standard size
- Available on request

	<b>Moulded</b> SAM10 Moulded width: 45mm	<b>Reeded</b> SAM3497 Moulded width: 54mm	<b>Hockey Stick</b> SAM502 Fits around architrave See adjacent photo			
<b>SAM<sup>®</sup>STOCK</b>						
<b>Fast track available</b> (See Stock section)	Yes	No	Yes			
<b>Thicknesses available (mm)</b>						
12	●	—	—			
14.5	●	—	—			
18	●	●	●			
22	●	●	●			
25	●	●	●			
30	●	●	●			
<b>Widths available (mm)</b>						
32	—	—	●			
44	—	—	—			
57	●	—	—			
69	●	●	—			
94	●	—	—			
119	●	—	—			
144	●	—	—			
169	●	—	—			
194	●	—	—			
Other sizes available on request	Yes	Yes	Yes			
<b>Finishes available</b>	 Unprimed Primed SAM Wrap SAM Zero	 Unprimed Primed	 Unprimed Primed SAM Wrap SAM Zero			
<b>SAM<sup>®</sup>XTRA</b>						
Architrave can be cut to size and mitred	Yes	Yes	Yes			
<b>Lengths available</b>						
Thickness (mm)	12	14.5	18	22	25	30
Length (m)	4.88, 5.49	3.66, 4.2, 4.4, 4.88, 5.49	3.66, 4.2, 4.4, 4.88, 5.49	4.4, 5.49	3.66, 4.2, 5.1, 5.49	4.2, 5.1



Practical  
Information

External Cladding  
& Panelling

Fascia & Soffit

Stair Accessories

Door Framing

Window Board

Internal Cladding  
& Panelling

Decorative  
Mouldings

Architrave &  
Plinth Blocks







Skirting &  
Architrave



# Stepped Profiles

Scale up a property's décor with our range of stepped profiles. Perfect for traditional buildings with a contemporary twist.



	<b>Lambs Tongue</b> SAM28 Moulded width: 34mm	<b>Square Stepped</b> SAM2117 Moulded width: Variable	<b>Round Stepped</b> SAM5317 Moulded width: 50mm
<b>SAM<sup>®</sup>STOCK</b>			
<b>Fast track available</b> (See Stock section)	Yes	No	No
<b>Thicknesses available</b> (mm)	14.5mm upwards	14.5mm upwards	18mm upwards
<b>Widths available</b> (mm)	44mm upwards	57mm upwards	57mm upwards
<b>Finishes available</b>	   Unprimed Primed SAM Wrap	  Unprimed Primed	  Unprimed Primed
<b>SAM<sup>®</sup>XTRA</b>			
Can be cut to size and mitred	Yes	Yes	Yes

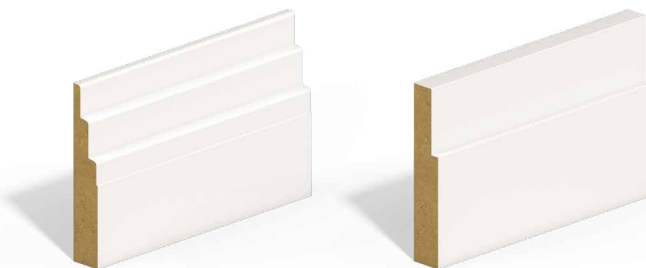

	<b>Chamfer Stepped</b> SAM5219 Moulded width: 50mm	<b>Rebated</b> SAM603 Moulded width: Variable
<b>SAM<sup>®</sup>STOCK</b>		
<b>Fast track available</b> (See Stock section)	Yes	No
<b>Thicknesses available</b> (mm)	22mm upwards	12mm upwards
<b>Widths available</b> (mm)	57mm upwards	44mm upwards
<b>Finishes available</b>	  Unprimed Primed	  Unprimed Primed
<b>SAM<sup>®</sup>XTRA</b>		
Can be cut to size and mitred	Yes	Yes

**Lengths available**

Thickness (mm)	12	14.5	18	22	25	30
Length (m)	4.88, 5.49	3.66, 4.2, 4.4, 4.88, 5.49	3.66, 4.2, 4.4, 4.88, 5.49	4.4, 5.49	3.66, 4.2, 5.1, 5.49	4.2, 5.1

# Period Profiles

Working on a Georgian style build or renovation? Our selection of period skirting and architrave will help to create or preserve the property's character.



**Victorian**  
SAM3525  
Moulded width: 93.5mm

## SAM<sup>®</sup>STOCK

<b>Fast track available</b> (See Stock section)	<b>Yes</b>
<b>Thicknesses available</b> (mm)	18mm upwards
<b>Widths available</b> (mm)	100mm upwards
<b>Finishes available</b>	  Unprimed Primed

## SAM<sup>®</sup>XTRA

Can be cut to size and mitred	<b>Yes</b>
-------------------------------	------------



**Georgian**  
SAM3518  
Moulded width: 48mm

## SAM<sup>®</sup>STOCK

<b>Fast track available</b> (See Stock section)	<b>Yes</b>
<b>Thicknesses available</b> (mm)	18mm upwards
<b>Widths available</b> (mm)	57mm upwards
<b>Finishes available</b>	  Unprimed Primed

## SAM<sup>®</sup>XTRA

Can be cut to size and mitred	<b>Yes</b>
-------------------------------	------------





	<b>Victorian</b> SAM3526 Moulded width: 110mm	<b>Tudor</b> SAM3523 Moulded width: 76mm	<b>Kensington</b> SAM3527 Moulded width: 96mm
<b>SAM<sup>®</sup>STOCK</b>			
<b>Fast track available</b> (See Stock section)	Yes	No	No
<b>Thicknesses available</b> (mm)	18mm upwards	18mm upwards	18mm upwards
<b>Widths available</b> (mm)	119mm upwards	90mm upwards	110mm upwards
<b>Finishes available</b>	  Unprimed Primed	  Unprimed Primed	  Unprimed Primed
<b>SAM<sup>®</sup>XTRA</b>			
Can be cut to size and mitred	Yes	Yes	Yes



	<b>Edwardian</b> SAM4887 Moulded width: 51.5mm	<b>Classic</b> SAM1730 Moulded width: 34.5mm	<b>Windsor</b> SAM935 Moulded width: 81.5mm
<b>SAM<sup>®</sup>STOCK</b>			
<b>Fast track available</b> (See Stock section)	Yes	No	No
<b>Thicknesses available</b> (mm)	18mm upwards	22mm upwards	22mm upwards
<b>Widths available</b> (mm)	69mm upwards	44mm upwards	94mm upwards
<b>Finishes available</b>	  Unprimed Primed	  Unprimed Primed	  Unprimed Primed
<b>SAM<sup>®</sup>XTRA</b>			
Can be cut to size and mitred	Yes	Yes	Yes

**Lengths available**

Thickness (mm)	12	14.5	18	22	25	30
Length (m)	4.88, 5.49	3.66, 4.2, 4.4, 4.88, 5.49	3.66, 4.2, 4.4, 4.88 5.49	4.4, 5.49	3.66, 4.2, 5.1, 5.49	4.2, 5.1

# Dual Purpose

When space is limited, but you still want to offer your customers a good selection of profiles, our dual purpose products are the solution. With a different profile on both sides, you can offer two style options using the same racking space.









**Ovolo SAM27 / Round & V-Groove SAM4288 SAM5378**

Moulded width: 35mm / Radius: 2mm & V-Groove dimensions (mm): (w)3 x (d)3







**SAM<sup>®</sup>STOCK**

<b>Fast track available</b> (See Stock section)	<b>Yes</b>
<b>Thicknesses available (mm)</b>	14.5mm upwards
<b>Widths available (mm)</b>	119mm upwards
<b>Finishes available</b>	  Unprimed    Primed
<b>SAM<sup>®</sup>XTRA</b>	
Can be cut to size and mitred	<b>Yes</b>



	<b>Chamfer &amp; Round SAM22 / Pencil Round SAM23</b> SAM2574 Chamfer width: 32mm Radius: 6mm	<b>Chamfer &amp; Round SAM22 / Pencil Round SAM23</b> SAM2285 Chamfer width: 32mm Radius: 6mm	<b>Torus SAM09 / Ogee SAM93</b> SAM2156 Moulded width: 32/45mm
<b>SAM<sup>®</sup>STOCK</b>			
<b>Fast track available</b> (See Stock section)	Yes	Yes	Yes
<b>Thicknesses available</b> (mm)	14.5mm upwards	18mm upwards	14.5mm upwards
<b>Widths available</b> (mm)	94mm upwards	94mm upwards	119mm upwards
<b>Finishes available</b>	  Unprimed Primed	  Unprimed Primed	  Unprimed Primed
<b>SAM<sup>®</sup>XTRA</b>			
Can be cut to size and mitred	Yes	Yes	Yes



	<b>Pencil Round SAM23 / Ovolo SAM27</b> SAM5381 Radius: 6mm / Moulded width: 35mm	<b>Square Edge SAM04 / Grooved SAM5059</b> SAM5383 Radius: 1.5mm / Groove dimensions (mm): 5 x 5 (20mm from edge)	<b>Grooved SAM5059 / Round &amp; V-Groove SAM4288</b> SAM5379 Groove dimensions (mm): 5 x 5 (20mm from edge) / Radius: 2mm & V-Groove dimensions (mm): (w)3 x (d)3
<b>SAM<sup>®</sup>STOCK</b>			
<b>Fast track available</b> (See Stock section)	Yes	Yes	Yes
<b>Thicknesses available</b> (mm)	14.5mm upwards	18mm upwards	14.5mm upwards
<b>Widths available</b> (mm)	94mm upwards	100mm upwards	119mm upwards
<b>Finishes available</b>	  Unprimed Primed	  Unprimed Primed	  Unprimed Primed
<b>SAM<sup>®</sup>XTRA</b>			
Can be cut to size and mitred	Yes	Yes	Yes

**Lengths available**

Thickness (mm)	12	14.5	18	22	25	30
Length (m)	4.88, 5.49	3.66, 4.2, 4.4, 4.88, 5.49	3.66, 4.2, 4.4, 4.88, 5.49	4.4, 5.49	3.66, 4.2, 5.1, 5.49	4.2, 5.1







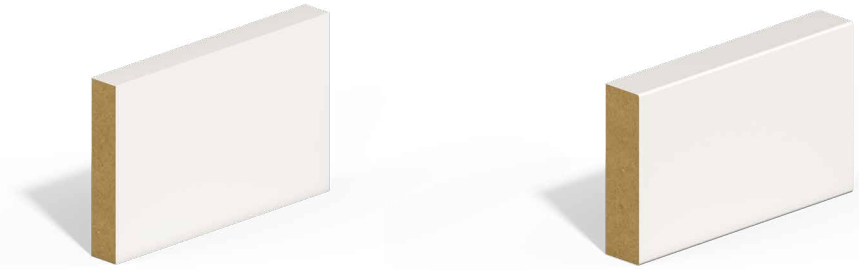

# Contemporary Profiles

If simple, sleek and sophisticated is more the style, SAM's range of contemporary profiles combines clean lines and edgy design. From square edge to rounded, grooved to fluted, we have something to cater for all styles and budgets.











- Standard size
- Available on request

	<b>Square Edge SAM01</b>	<b>Square Edge SAM04 Radius: 1.5mm</b>
<b>SAM<sup>®</sup>STOCK</b>		
<b>Fast track available</b> (See Stock section)	Yes	Yes
<b>Thicknesses available (mm)</b>		
12	●	●
14.5	●	●
18	●	●
22	●	●
25	●	●
30	●	●
<b>Widths available (mm)</b>		
44	●	●
57	●	●
69	●	●
94	●	●
119	●	●
144	●	●
169	●	●
194	●	●
Other sizes available on request	Yes	Yes
<b>Finishes available</b>	  Unprimed Primed	    Unprimed Primed SAM Wrap SAM Zero
<b>SAM<sup>®</sup>XTRA</b>		
Architrave can be cut to size and mitred	Yes	Yes

<b>Lengths available</b>						
Thickness (mm)	12	14.5	18	22	25	30
Length (m)	4.88, 5.49	3.66, 4.2, 4.4, 4.88, 5.49	3.66, 4.2, 4.4, 4.88, 5.49	4.4, 5.49	3.66, 4.2, 5.1, 5.49	4.2, 5.1









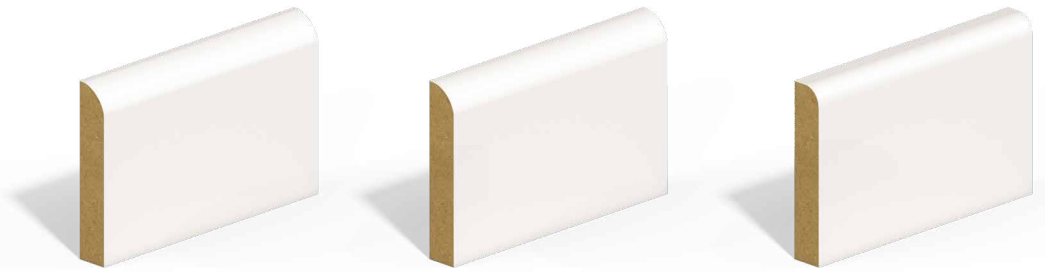





- Standard size
- Available on request

	<b>Pencil Round One Edge</b> SAM23 Radius: 6mm	<b>Pencil Round Two Edge</b> SAM24 Radius: 6mm
<b>SAM<sup>®</sup>STOCK</b>		
<b>Fast track available</b> (See Stock section)	Yes	Yes
<b>Thicknesses available (mm)</b>		
12	●	●
14.5	●	●
18	●	●
22	●	●
25	●	●
30	●	●
<b>Widths available (mm)</b>		
44	●	●
57	●	●
69	●	●
94	●	●
119	●	●
144	●	●
169	●	●
194	●	●
Other sizes available on request	Yes	Yes
<b>Finishes available</b>	    Unprimed Primed SAM Wrap SAM Zero	    Unprimed Primed SAM Wrap SAM Zero
<b>SAM<sup>®</sup>XTRA</b>		
Architrave can be cut to size and mitred	Yes	Yes

<b>Lengths available</b>						
Thickness (mm)	12	14.5	18	22	25	30
Length (m)	4.88, 5.49	3.66, 4.2, 4.4, 4.88, 5.49	3.66, 4.2, 4.4, 4.88, 5.49	4.4, 5.49	3.66, 4.2, 5.1, 5.49	4.2, 5.1









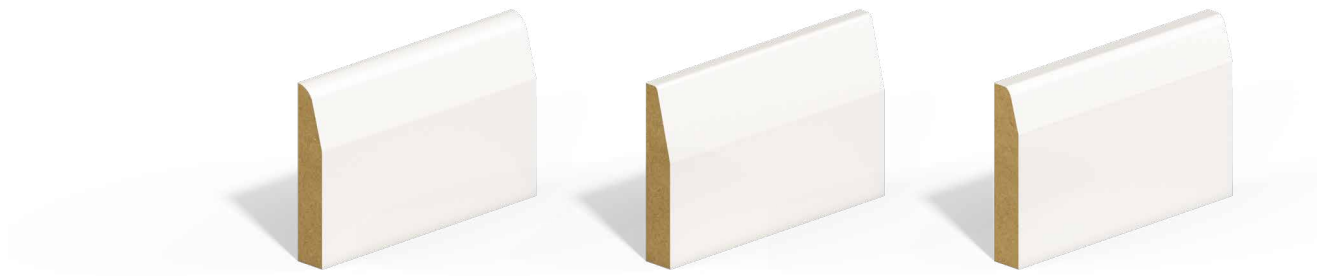





- Standard size
- Available on request

	<b>Bullnose SAM29</b> Radius: 20mm	<b>Bullnose SAM1855</b> Radius: 17mm	<b>Bullnose SAM20</b> Radius: 10mm
<b>SAM<sup>®</sup>STOCK</b>			
<b>Fast track available</b> (See Stock section)	Yes	Yes	Yes
<b>Thicknesses available (mm)</b>			
12	●	●	●
14.5	●	●	●
18	●	●	●
22	●	●	●
25	●	●	●
30	●	●	●
<b>Widths available (mm)</b>			
44	●	●	●
57	●	●	●
69	●	●	●
94	●	●	●
119	●	●	●
144	●	●	●
169	●	●	●
194	●	●	●
Other sizes available on request	Yes	Yes	Yes
<b>Finishes available</b>	   	   	   
<b>SAM<sup>®</sup>XTRA</b>			
Architrave can be cut to size and mitred	Yes	Yes	Yes

<b>Lengths available</b>						
Thickness (mm)	12	14.5	18	22	25	30
Length (m)	4.88, 5.49	3.66, 4.2, 4.4, 4.88, 5.49	3.66, 4.2, 4.4, 4.88, 5.49	4.4, 5.49	3.66, 4.2, 5.1, 5.49	4.2, 5.1



- Standard size
- Available on request







	<b>Chamfer &amp; Round SAM22</b> Chamfer width: 32mm	<b>Chamfer &amp; Round SAM26</b> Chamfer width: 38mm	<b>Chamfer &amp; Round SAM1959</b> Chamfer width: 23mm
<b>SAM<sup>®</sup>STOCK</b>			
<b>Fast track available</b> (See Stock section)	Yes	Yes	Yes
<b>Thicknesses available (mm)</b>			
12	●	●	●
14.5	●	●	●
18	●	●	●
22	●	●	●
25	●	●	●
30	●	●	●
<b>Widths available (mm)</b>			
44	●	●	●
57	●	●	●
69	●	●	●
94	●	●	●
119	●	●	●
144	●	●	●
169	●	●	●
194	●	●	●
Other sizes available on request	Yes	Yes	Yes
<b>Finishes available</b>	   	   	   
<b>SAM<sup>®</sup>XTRA</b>			
Architrave can be cut to size and mitred	Yes	Yes	Yes

<b>Lengths available</b>						
Thickness (mm)	12	14.5	18	22	25	30
Length (m)	4.88, 5.49	3.66, 4.2, 4.4, 4.88, 5.49	3.66, 4.2, 4.4, 4.88, 5.49	4.4, 5.49	3.66, 4.2, 5.1, 5.49	4.2, 5.1





- Standard size
- Available on request

	<b>Chamfered SAM5061</b> Chamfer dimensions: 6x6mm	<b>Chamfered SAM5062</b> Chamfer dimensions: 10x10mm
<b>SAM<sup>®</sup>STOCK</b>		
<b>Fast track available</b> (See Stock section)	Yes	Yes
<b>Thicknesses available (mm)</b>		
12	●	●
14.5	●	●
18	●	●
22	●	●
25	●	●
30	●	●
<b>Widths available (mm)</b>		
44	●	●
57	●	●
69	●	●
94	●	●
119	●	●
144	●	●
169	●	●
194	●	●
Other sizes available on request	Yes	Yes
<b>Finishes available</b>	    Unprimed Primed SAM Wrap SAM Zero	    Unprimed Primed SAM Wrap SAM Zero
<b>SAM<sup>®</sup>XTRA</b>		
Architrave can be cut to size and mitred	Yes	Yes

<b>Lengths available</b>						
Thickness (mm)	12	14.5	18	22	25	30
Length (m)	4.88, 5.49	3.66, 4.2, 4.4, 4.88, 5.49	3.66, 4.2, 4.4, 4.88 5.49	4.4, 5.49	3.66, 4.2, 5.1, 5.49	4.2, 5.1



## Grooved & Fluted

Grooved skirting and architrave have seen a surge in popularity in recent years and with our selection of square groove, v-groove, single groove and double groove profiles, we are sure there is a moulding to fit all tastes.









- Standard size
- Available on request

	<b>Chamfer &amp; Single V-Groove</b> <b>SAM2975</b> Chamfer dimensions: 5x5mm V-Groove dimensions: (w)6x(d)3mm	<b>Chamfer &amp; Double V-Groove</b> <b>SAM2984</b> Chamfer dimensions: 5x5mm V-Groove dimensions: (w)6x(d)3mm	<b>Round &amp; V-Groove</b> <b>SAM4288</b> Radius: 2mm V-Groove dimensions: (w)3x(d)3mm
<b>SAM<sup>®</sup>STOCK</b>			
<b>Fast track available</b> (See Stock section)	Yes	Yes	Yes
<b>Thicknesses available (mm)</b>			
12	●	●	●
14.5	●	●	●
18	●	●	●
22	●	●	●
25	●	●	●
30	●	●	●
<b>Widths available (mm)</b>			
44	●	—	●
57	●	●	●
69	●	●	●
94	●	●	●
119	●	●	●
144	●	●	●
169	●	●	●
194	●	●	●
Other sizes available on request	Yes	Yes	Yes
<b>Finishes available</b>	 Unprimed Primed	 Unprimed Primed	 Unprimed Primed
<b>SAM<sup>®</sup>XTRA</b>			
Architrave can be cut to size and mitred	Yes	Yes	Yes

<b>Lengths available</b>						
Thickness (mm)	12	14.5	18	22	25	30
Length (m)	4.88, 5.49	3.66, 4.2, 4.4, 4.88, 5.49	3.66, 4.2, 4.4, 4.88, 5.49	4.4, 5.49	3.66, 4.2, 5.1, 5.49	4.2, 5.1







- Standard size
- Available on request

	<b>Single Groove</b> <b>SAM600</b> Groove dimensions: Variable	<b>Double Groove</b> <b>SAM936</b> Groove dimensions: Variable	<b>Chamfer &amp; Single Groove</b> <b>SAM923</b> Chamfer & Groove dimensions: Variable
<b>SAM<sup>®</sup>STOCK</b> <b>Fast track available</b> (See Stock section)	Yes (SAM5059 & SAM5060)	No	No
<b>Thicknesses available (mm)</b>			
12	●	●	●
14.5	●	●	●
18	●	●	●
22	●	●	●
25	●	●	●
30	●	●	●
<b>Widths available (mm)</b>			
44	●	●	●
57	●	●	●
69	●	●	●
94	●	●	●
119	●	●	●
144	●	●	●
169	●	●	●
194	●	●	●
Other sizes available on request	Yes	Yes	Yes
<b>Finishes available</b>	  Unprimed Primed	  Unprimed Primed	  Unprimed Primed
<b>SAM<sup>®</sup>XTRA</b> Architrave can be cut to size and mitred	Yes	Yes	Yes

<b>Lengths available</b>						
Thickness (mm)	12	14.5	18	22	25	30
Length (m)	4.88, 5.49	3.66, 4.2, 4.4, 4.88, 5.49	3.66, 4.2, 4.4, 4.88, 5.49	4.4, 5.49	3.66, 4.2, 5.1, 5.49	4.2, 5.1







- Standard size
- Available on request

<b>SAM<sup>®</sup>STOCK</b>	<b>Chamfer &amp; Double Groove SAM1426</b> Chamfer & Groove dimensions: Variable	<b>Round &amp; Single Groove SAM933</b> Round & Groove dimensions: Variable	<b>Round &amp; Double Groove SAM2194</b> Round & Groove dimensions: Variable
<b>Fast track available</b> (See Stock section)	No	No	No
<b>Thicknesses available (mm)</b>			
12	●	●	●
14.5	●	●	●
18	●	●	●
22	●	●	●
25	●	●	●
30	●	●	●
<b>Widths available (mm)</b>			
44	—	●	—
57	●	●	●
69	●	●	●
94	●	●	●
119	●	●	●
144	●	●	●
169	●	●	●
194	●	●	●
Other sizes available on request	Yes	Yes	Yes
<b>Finishes available</b>	  Unprimed Primed	  Unprimed Primed	  Unprimed Primed
<b>SAM<sup>®</sup>XTRA</b> Architrave can be cut to size and mitred	Yes	Yes	Yes

<b>Lengths available</b>						
Thickness (mm)	12	14.5	18	22	25	30
Length (m)	4.88, 5.49	3.66, 4.2, 4.4, 4.88, 5.49	3.66, 4.2, 4.4, 4.88, 5.49	4.4, 5.49	3.66, 4.2, 5.1, 5.49	4.2, 5.1



- Standard size
- Available on request

	<b>Single Flute</b> SAM5003 Flute dimensions (mm): (w)15 x (d)5	<b>Double Flute</b> SAM5002 Flute dimensions (mm): (w)15 x (d)5
<b>SAM<sup>®</sup>STOCK</b>		
<b>Fast track available</b> (See Stock section)	No	No
<b>Thicknesses available (mm)</b>		
12	●	●
14.5	●	●
18	●	●
22	●	●
25	●	●
30	●	●
<b>Widths available (mm)</b>		
44	●	—
57	●	—
69	●	—
94	●	●
119	●	●
144	●	●
169	●	●
194	●	●
Other sizes available on request	Yes	Yes
<b>Finishes available</b>	  Unprimed   Primed	  Unprimed   Primed
<b>SAM<sup>®</sup>XTRA</b>		
Architrave can be cut to size and mitred	Yes	Yes

<b>Lengths available</b>						
Thickness (mm)	12	14.5	18	22	25	30
Length (m)	4.88, 5.49	3.66, 4.2, 4.4, 4.88, 5.49	3.66, 4.2, 4.4, 4.88, 5.49	4.4, 5.49	3.66, 4.2, 5.1, 5.49	4.2, 5.1



Practical  
Information

External Cladding  
& Panelling

Fascia & Soffit

Stair Accessories

Door Framing

Window Board

Internal Cladding  
& Panelling

Decorative  
Mouldings

Architrave &  
Plinth Blocks

Skirting &  
Architrave





# Architrave & Plinth Blocks

Make a statement with our range of architrave and plinth blocks, from simple design to ornate grandeur. Combine with one of our period skirting and architrave profiles to maintain character in an older property or use with a simple contemporary profile for greater impact.

---

Edging options Page 43

---

Architrave facing Page 44

---

Plinth facing Page 44



# Architrave & Plinth Blocks

Historically, architrave and plinth blocks were used in period properties to overcome the dilemma of uneven walls. By adding a block that was thicker, wider and higher than the skirting or architrave, it removed the need for the mouldings to be flush at the joint and avoided complex joinery work for more detailed profiles. This typically isn't necessary in new build or renovated properties, but plinth and architrave blocks are still used to maintain the character of a period property or simply to create a visual statement.

## Edging options\*

*\*Edging detail for architrave blocks is on all four edges.  
Plinth blocks have edging detail on three edges.*



**A) Square**

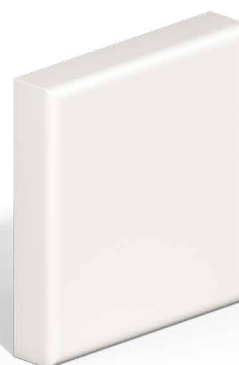

**B) Pencil**  
5mm Radius



**C) Chamfer Edge**  
3mm x 3mm



**D) Ovolo**  
6mm wide x 6mm deep



To order, please provide our internal sales team with the face and edging detail, thickness, width, height and quantity needed. This is a made-to-order product, so minimum order quantities will apply.

## Facing options

## Architrave Blocks

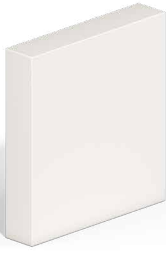

**Plain Face**  
AR01



**Bullseye Small**  
AR02  
63mm diameter  
with 13mm centre



**Bullseye Large**  
AR03  
75mm diameter  
with 25mm centre



**Tulip Small**  
AR07  
51mm diameter



**Tulip Large**  
AR06  
60mm diameter



**Fluted**  
AR08  
6, 8 or 10mm wide flutes  
available equally spaced

## Plinth Blocks



**Plain Face**  
SK01



**Bullseye Small**  
SK02  
63mm diameter with 13mm centre



**Bullseye Large**  
SK03  
75mm diameter with 25mm centre



**Tulip Small**  
SK07  
51mm diameter



**Tulip Large**  
SK06  
60mm diameter

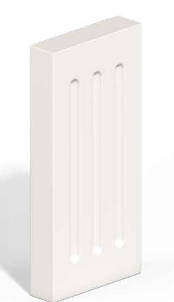

**Fluted**  
SK08  
6, 8 or 10mm wide flutes  
available equally spaced



# Decorative Mouldings

Ceiling cornice, wall panelling and decorative trims can transform a space and they provide a relatively low-cost solution to create a timeless, classic and elevated look in any property.

---

Ceiling Cornice Page 47

---

Picture Rail Page 49

---

Dado Rail Page 49



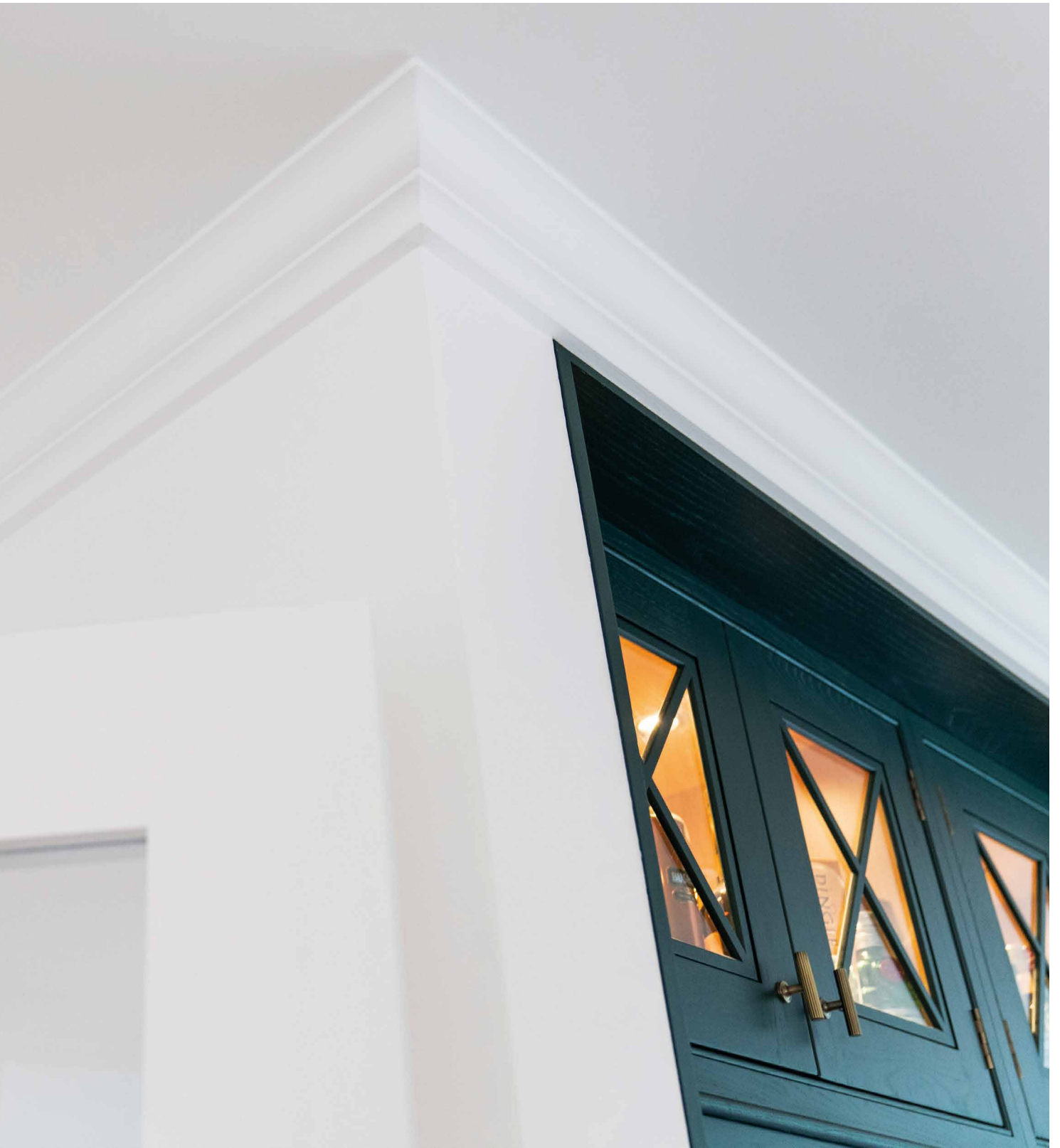



# Ceiling Cornice

Finish a property in style with our elegant range of MDF ceiling cornice, creating a visually attractive transition from wall to ceiling.



	Ceiling Cornice SAM719	Ceiling Cornice SAM3031
Thicknesses available (mm)	30mm	18mm
Widths available (mm)	122mm	115mm
Finishes available	  Unprimed Primed	  Unprimed Primed



	Ceiling Cornice SAM3770	Ceiling Cornice SAM70
Thicknesses available (mm)	12mm	25mm
Widths available (mm)	77mm	140mm
Finishes available	  Unprimed Primed	 Unprimed

**Lengths available**

Thickness (mm)	12	14.5	18	22	25	30
Length (m)	4.88, 5.49	3.66, 4.2, 4.4, 4.88, 5.49	3.66, 4.2, 4.4, 4.88 5.49	4.4, 5.49	3.66, 4.2, 5.1, 5.49	4.2, 5.1



**SAM<sup>®</sup> BESPOKE**

We can help to match existing profiles or images.



## Picture Rail

Picture rail mouldings are fitted horizontally around a room typically aligning with the tops of the windowpanes, although they can also be positioned higher on the wall. They are often used for decorative purposes but can still be as functional today as they were one hundred years ago – to hang pictures!









## Dado Rail







Dado rail was used in period properties to protect the walls from furniture. It was fitted to the wall at chair height to avoid dents or scrapes on the paintwork or wallpaper. Today, it is mainly used as a decorative trim for wall cladding or panelling.





	Picture Rail SAM1960	Picture Rail SAM1334	Picture Rail SAM2027
Thicknesses available (mm)	18mm	22mm	18mm, 22mm
Widths available (mm)	44mm	40mm	55mm
Finishes available	  Unprimed Primed	  Unprimed Primed	  Unprimed Primed



	Dado Rail SAM85	Dado Rail SAM4152	Dado Rail SAM38
Thicknesses available (mm)	18mm	18mm	18mm
Widths available (mm)	57mm	44mm	57mm
Finishes available	  Unprimed Primed	  Unprimed Primed	  Unprimed Primed

**Lengths available**

Thickness (mm)	14.5	18	22
Length (m)	4.2, 5.49	4.2, 5.49	5.49





# Internal Cladding & Panelling

Internal cladding and panelling are popular finishing products for walls, adding depth and character to any space. MDF cladding is easy to fit, versatile and offers a smooth surface for hassle free painting. If you want to avoid painting altogether, our cladding is also available fully finished.

---

**Internal Cladding** **Page 53**

---

**Panelling Strips** **Page 53**













# Internal Cladding & Panelling

The options are endless when it comes to internal cladding and panelling and it can create a high visual impact in a property at a relatively low cost. Our tongue and v-groove cladding can be used vertically or horizontally and can be finished with decorative mouldings, such as the SAM dado rail, or shelving. Panelling is popular in a variety of patterns, from the classic shaker or a contemporary geometric design using the wall or MDF board as a base with a square edge moulding, to a more heritage style using decorative trims and mouldings.



- Standard size
- Available on request

<b>SAM<sup>®</sup>STOCK</b>	<b>Tongue &amp; Groove SAM3012 TG&amp;V</b>	<b>Square Edge SAM01</b>	<b>Square Edge SAM04 Radius: 1.5mm</b>
<b>Fast track available</b> (See Stock section)	Yes	Yes	Yes
<b>Thicknesses available (mm)</b>			
9	●	●	●
12	●	●	●
14.5	—	●	●
18	—	●	●
22	—	●	●
25	—	●	●
30	—	●	●
<b>Widths available (mm)</b>			
32	—	●	●
44	—	●	●
57	—	●	●
69	—	●	●
94	●	●	●
119	●	●	●
144	●	●	●
169	●	●	●
194	●	●	●
Other sizes available on request	No	Yes	Yes
<b>Finishes available</b>	 Unprimed  Primed  SAM Zero	 Unprimed  Primed	 Unprimed  Primed  SAM Wrap  SAM Zero

**Lengths available**

Thickness (mm)	9	12	14.5	18	22	25	30
Length (m)	4.8	5.49	4.2, 5.49	4.2, 5.49	5.49	3.66, 5.1, 5.49	4.2, 5.1



# Window Board

A highly durable and moisture resistant solution to cover the gap between the inside wall and window. Free from defects and knots, SAM window board provides a consistently smooth surface for a premium paint finish. If you want to save labour time on finishing, it is also available veneer wrapped or fully finished.











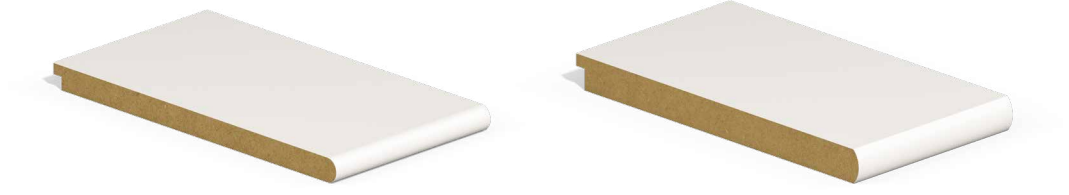

# Window Board

SAM MDF window board can be provided in long lengths, or using our SAM Xtra service, it can be cut to size with returned ends to save time during installation.





- Standard size
- Available on request

	<b>Window Board SAM50</b> Bullnosed & Rebated	<b>Window Board SAM52</b> Bullnosed & Rebated
<b>SAM<sup>®</sup>STOCK</b>		
<b>Fast track available</b> (See Stock section)	Yes	Yes
<b>Thicknesses available (mm)</b>		
12	—	—
14.5	●	—
18	●	—
22	—	●
25	—	●
30	●	—
<b>Widths available (mm)</b>		
94	●	●
119	●	●
144	●	●
169	●	●
194	●	●
219	●	●
244	●	●
269	●	●
294	●	●
Other sizes available on request	Yes	Yes
<b>Finishes available</b>	    Unprimed Primed SAM Wrap SAM Zero	    Unprimed Primed SAM Wrap SAM Zero
<b>SAM<sup>®</sup>XTRA</b>		
Can be cut to size and bullnosed on 3 sides	Yes	Yes

<b>Lengths available</b>					
Thickness (mm)	14.5	18	22	25	30
Length (m)	4.2, 5.49	3.66, 4.2, 5.49	4.4, 5.49	3.66, 4.2, 5.1, 5.49	4.2, 5.1



# Door Framing

There are several door framing options available from SAM, each offering time and cost saving benefits over alternative products.



# Door Framing

## Why choose MDF for door frames?

- No knots, splits or defects reduces wastage
- It is supplied in standard lengths meaning the little wastage can be easily calculated
- The smooth and consistent texture makes paint application easy and provides an excellent finish
- The consistent finish means a series of doors will look the same
- Extra wide sizes are available simplifying installation for bespoke door openings
- Fire resistant options are available.

## Door lining options

---

### Standard door linings

Our standard door linings are manufactured to meet end user specification and they consist of a door lining and a door stop. They are quick and easy to install and provide a consistently smooth surface for painting.

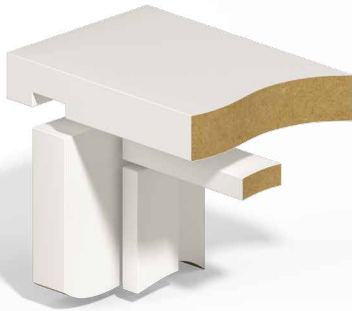

### Adjustable door linings

SAM adjustable door linings consist of a door lining and a door stop and they are manufactured with rebated legs to allow for variable door widths and to save time during installation.



### Reversible door linings

SAM reversible door linings consist of a door lining and a door stop. The heads are trenched on both sides and provide time saving benefits when working with two different standard door widths.

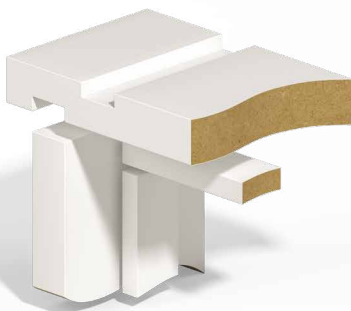







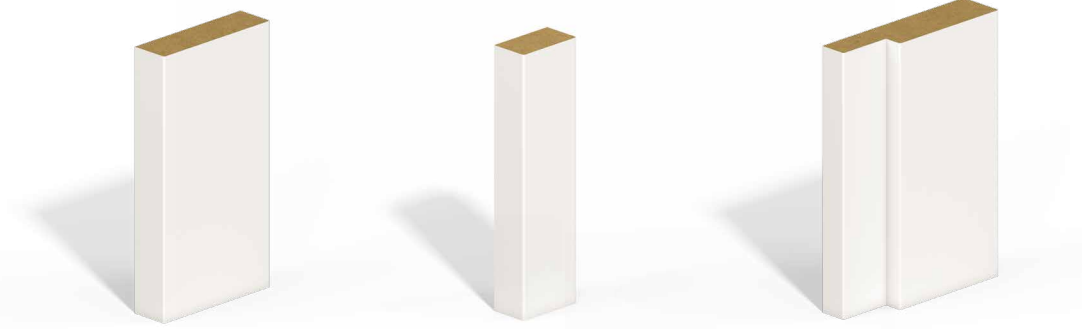





### H frame door linings

H frame door linings are manufactured to meet end user specification. They consist of a door lining and door stop with the addition of grooves to fit tongued architrave for quick and easy installation.





- Standard size
- Available on request

	<b>Door Lining</b> SAM04 Radius: 1.5mm	<b>Door Stop</b> SAM04 Radius: 1.5mm	<b>Door Casing</b> SAM02 Radius: 1.5mm Rebate: 35-47mm
<b>SAM<sup>®</sup>STOCK</b>			
<b>Fast track available</b> (See Stock section)	Yes	Yes	No
<b>Thicknesses available (mm)</b>			
12	—	●	—
14.5	—	●	—
18	—	●	—
22	●	—	—
25	●	—	—
30	●	—	●
<b>Widths available (mm)</b>	74mm upwards	20mm upwards	74mm upwards
Other sizes available on request	No	Yes	No
<b>Finishes available</b>	    Unprimed Primed SAM Wrap SAM Zero	    Unprimed Primed SAM Wrap SAM Zero	    Unprimed Primed SAM Wrap SAM Zero
<b>SAM<sup>®</sup>XTRA</b>			
Door framing can be cut to size	Yes	Yes	Yes
Heads & legs can be trenched	Yes	N/A	Yes
Heads & legs can be rebated	Yes	N/A	Yes
Legs can be recessed for hinges & latches	Yes	N/A	Yes
Pilot holes can be pre-drilled	Yes	N/A	Yes
Intumescent strip installation available	Yes	N/A	Yes
Hinge installation available	Yes	N/A	Yes

**Lengths available**

Thickness (mm)	12	14.5	18	22	25	30
Length (m)	4.88, 5.49	3.66, 4.2, 4.4, 4.88, 5.49	3.66, 4.2, 4.4, 4.88 5.49	4.4, 5.49	3.66, 4.2, 5.1, 5.49	4.2, 5.1



- Standard size
- Available on request

	<b>Single Groove Lining</b> <b>SAM730</b> Radius: 1.5mm Groove: Variable	<b>Single Groove Casing</b> <b>SAM654</b> Radius: 1.5mm Rebate: 35-47mm Groove: Variable	<b>Double Groove Lining</b> <b>SAM956</b> Radius: 1.5mm Grooves: Variable
<b>SAM<sup>®</sup>STOCK</b>			
<b>Fast track available</b> (See Stock section)	No	No	No
<b>Thicknesses available (mm)</b>			
22	●	—	●
25	●	—	●
30	●	●	●
<b>Widths available (mm)</b>	74mm upwards	74mm upwards	74mm upwards
Other sizes available on request	Yes	Yes	Yes
<b>Finishes available</b>	 Unprimed Primed SAM Wrap SAM Zero	 Unprimed Primed SAM Wrap SAM Zero	 Unprimed Primed SAM Wrap SAM Zero
<b>SAM<sup>®</sup>XTRA</b>			
Door framing can be cut to size	Yes	Yes	Yes
Heads & legs can be trenched	Yes	Yes	Yes
Heads & legs can be rebated	Yes	Yes	Yes
Legs can be recessed for hinges & latches	Yes	Yes	Yes
Pilot holes can be pre-drilled	Yes	Yes	Yes
Intumescent strip installation available	Yes	Yes	Yes
Hinge installation available	Yes	Yes	Yes

**Lengths available**

Thickness (mm)	12	14.5	18	22	25	30
Length (m)	4.88, 5.49	3.66, 4.2, 4.4, 4.88, 5.49	3.66, 4.2, 4.4, 4.88 5.49	4.4, 5.49	3.66, 4.2, 5.1, 5.49	4.2, 5.1

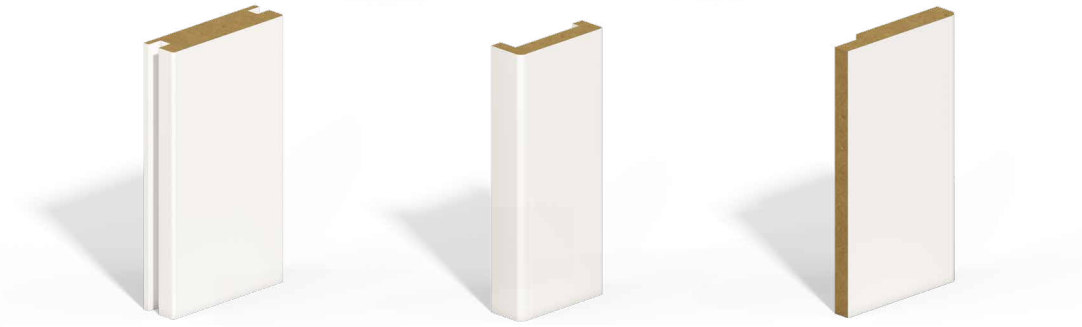

- Standard size
- Available on request

	<b>H Frame</b> SAM3603 Radius: 2mm	<b>Tongued Architrave</b> SAM4017 Radius: 2mm & 4mm Groove: 53mm	<b>Extension Liner</b> SAM975 Radius: Variable Rebate: Variable
<b>SAM<sup>®</sup>STOCK</b>			
<b>Fast track available</b> (See Stock section)	No	No	No
<b>Thicknesses available</b> (mm)			
18	—	—	●
25	●	●	—
<b>Widths available</b> (mm)	74mm upwards	44mm upwards	74mm upwards
Other sizes available on request	Yes	Yes	Yes
<b>Finishes available</b>	 Unprimed Primed SAM Wrap	 Unprimed Primed SAM Wrap	 Unprimed Primed SAM Wrap
<b>SAM<sup>®</sup>XTRA</b>			
Door framing can be cut to size	Yes	Yes	Yes
Heads & legs can be trenched	Yes	N/A	N/A
Heads & legs can be rebated	Yes	N/A	N/A
Legs can be recessed for hinges & latches	Yes	N/A	N/A
Pilot holes can be pre-drilled	Yes	N/A	N/A
Intumescent strip installation available	Yes	N/A	N/A
Hinge installation available	Yes	N/A	N/A

**Lengths available**

Thickness (mm)	12	14.5	18	22	25	30
Length (m)	4.88, 5.49	3.66, 4.2, 4.4, 4.88, 5.49	3.66, 4.2, 4.4, 4.88 5.49	4.4, 5.49	3.66, 4.2, 5.1, 5.49	4.2, 5.1







# Stair Accessories

SAM manufactures components for staircases including treads and risers. These products are made using either standard grade or moisture resistant MDF based on customer requirements.

---

**Stair Treads** **Page 67**

---

**Stair Risers** **Page 67**





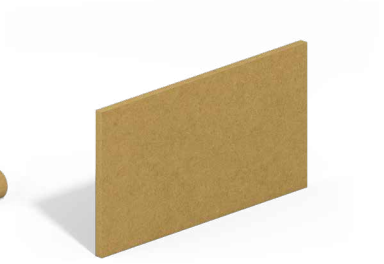

# Stair Accessories

SAM stair treads, the horizontal part of the step that a person will stand on, and risers, the vertical space between steps, are supplied unprimed so they can be painted or carpeted as per property or owner specification.



● Standard size

	<b>Stair Tread SAM55</b> Radius: 11mm Groove: Variable	<b>Stair Tread SAM56</b> Radius: 12.5mm Groove: Variable	<b>Stair Riser SAM01</b>
<b>Thicknesses available (mm)</b>			
9	—	—	●
12	—	—	●
14.5	—	—	●
18	—	—	●
22	●	—	●
25	—	●	—
<b>Widths available (mm)</b>	90mm upwards	90mm upwards	32mm upwards
Other sizes available on request	Yes	Yes	Yes
<b>Finishes available</b>	 Unprimed	 Unprimed	 Unprimed
<b>SAM<sup>®</sup>XTRA</b> Stair accessories can be cut to size	Yes	Yes	Yes

**Standard grade lengths available**

Thickness (mm)	9	12	14.5	18	22	25
Length (m)	2.44, 3.05	3.05	2.44, 3.05	3.05	2.44, 3.05	2.44, 3.05, 5.49

**Moisture resistant lengths available**

Thickness (mm)	9	12	14.5	18	22	25
Length (m)	4.88	4.88, 5.49	3.66, 4.2, 4.4, 4.88, 5.49	3.66, 4.2, 4.4, 4.88, 5.49	4.4, 5.49	3.66, 4.2, 5.1, 5.49



Stair accessories can be supplied in standard grade or moisture resistant MDF. Please specify preference when ordering.



# Fascia & Soffit

SAM Extreme fascia and soffit are manufactured using MEDITE TRICOYA EXTREME (MTX) and they are lightweight and easy to install. They are excellent value for money over the lifespan of the product and they can be supplied fully finished in any RAL colour.











# Fascia & Soffit

Manufactured using MEDITE TRICOYA EXTREME (MTX), these low maintenance products perform well in even the most extreme climates or locations. Where alternative solutions may require maintenance due to cracked paint or discolouration every few years, SAM Extreme will stand the test of time ensuring the property looks its best for longer.



**Plain Fascia**  
SAM5293  
Radius: 2mm







**Profiled Fascia**  
SAM5292  
Radius: 2mm

	<b>Plain Fascia</b> SAM5293 Radius: 2mm	<b>Profiled Fascia</b> SAM5292 Radius: 2mm
<b>Thicknesses available (mm)</b>	15mm	15mm
<b>Widths available (mm)</b>	57mm upwards	57mm upwards
<b>External finishes available</b>	   Unprimed   Primed   Fully finished	   Unprimed   Primed   Fully finished



**Soffit**  
SAM5348  
Radius: 3mm

**Stormboard**  
SAM3191  
Radius: 3mm

	<b>Soffit</b> SAM5348 Radius: 3mm	<b>Stormboard</b> SAM3191 Radius: 3mm
<b>Thicknesses available (mm)</b>	12mm	15mm
<b>Widths available (mm)</b>	57mm upwards	57mm upwards
<b>External finishes available</b>	   Unprimed   Primed   Fully finished	   Unprimed   Primed   Fully finished







# External Cladding & Panelling

Manufactured using MEDITE TRICOYA EXTREME (MTX) our external cladding and panelling add a decorative flair to building facades. From shop fronts and office blocks to luxury houses, garden rooms and beach huts, SAM Extreme cladding resists the elements whatever the location.

---

External Cladding Page 75

---

External Panelling Page 75









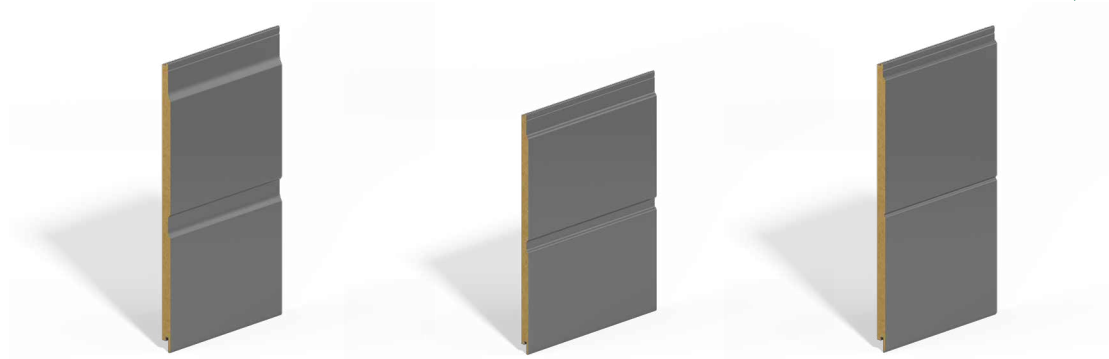







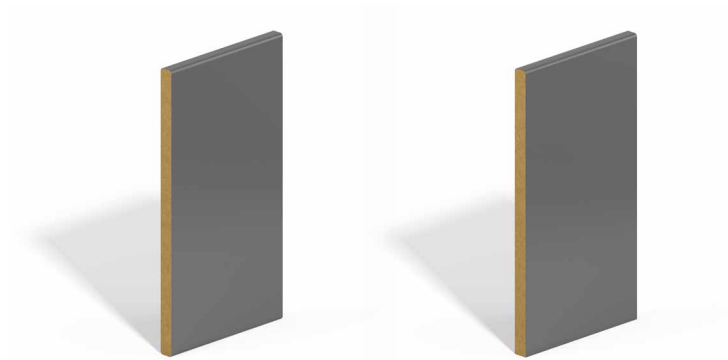

# External Cladding & Panelling

Manufactured using MEDITE TRICOYA EXTREME (MTX), our cladding can be installed vertically or horizontally to suit more traditional or coastal styles. If the property has a modern aesthetic, panelling can be cut to any size and fully finished to provide a sleek look with clean lines.



	<b>Double Shiplap</b> SAM3907	<b>Double Square Shiplap</b> SAM3717	<b>Double tongue &amp; V-groove</b> SAM4460
<b>Thicknesses available (mm)</b>	12mm	12mm	12mm
<b>Widths available (mm)</b>	294mm upwards	294mm upwards	294mm upwards
<b>External finishes available</b>	 Unprimed  Primed  Fully finished	 Unprimed  Primed  Fully finished	 Unprimed  Primed  Fully finished



	<b>Stormboard</b> SAM3191 Radius: 3mm	<b>Panels</b> SAM00 Radius: 6mm
<b>Thicknesses available (mm)</b>	15mm	12mm upwards
<b>Widths available (mm)</b>	169mm upwards	20mm - 600mm
<b>External finishes available</b>	 Unprimed  Primed  Fully finished	 Unprimed  Primed  Fully finished





# Practical Information

Whether you are considering SAM MDF products or have already purchased them, the information in this section should help make the process easier.

---

**Practical Information** **Page 79**

---

**Fixing Instructions** **Page 81**

---

**Safety Instructions** **Page 83**



# Practical Information

## SAM MDF mouldings imperial to metric conversion chart

NOMINAL IMPERIAL	SAM FINISHED SIZE METRIC
2 inches	44mm
2¼ inches	57mm
3 inches	69mm
4 inches	94mm
5 inches	119mm
6 inches	144mm
7 inches	169mm
8 inches	194mm
9 inches	219mm
10 inches	244mm
11 inches	269mm
12 inches	294mm

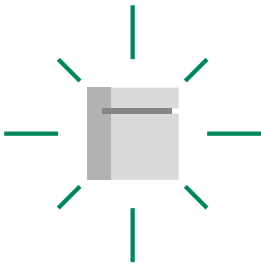

### Ordering samples

We understand that it is important for some of your customers to see a physical sample of the product before placing an order. For this reason, we keep all our stock profiles (in at least one size) in the sample store to ensure quick delivery.

If the sample request is for a made-to-order item, we can quickly produce a 3D printed sample along with a stock sample in the preferred finish.

You can order samples on the SAM website or by emailing [marketing@samonline.co.uk](mailto:marketing@samonline.co.uk).



### Sales enquiries

For all sales enquiries, including quote requests, please email [sales@samonline.co.uk](mailto:sales@samonline.co.uk) or phone +44 (0)28 9442 8288 (Option 1).

For quote requests, please provide:

- Profile number (if you are unsure, please attach a CAD drawing or image to the email)
- Dimensions if available (length, thickness, width)
- Quantity

A member of our internal sales team will be happy to help.



### Placing an order

Once a trade account has been created for your company, you can order SAM products using a valid purchase order number.

Please send any orders to [orders@samonline.co.uk](mailto:orders@samonline.co.uk) and our internal sales team will process these as quickly as possible.

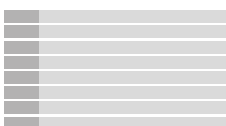

### Storing & handling your SAM MDF mouldings

SAM MDF mouldings products should be stored on dry bases and under cover. They should be fully supported on a flat and level surface with ample ventilation provided to reduce the risk of absorbing moisture. Any protective wrapping should be left in place until time of use.

It is recommended that SAM MDF mouldings are allowed to remain in the fixing environment for approximately 24 hours before use.

**Please note, extra care should be taken when handling SAM fully finished products to avoid any surface damage during transit and fitting.**

# Fixing Instructions

## SAM<sup>®</sup> MOULDINGS

### Primed

We recommend that you don't fix SAM MDF mouldings to damp plaster or any other damp materials. SAM MDF Mouldings are easy to fix using traditional tools and materials. Before being fixed in place, all cut or unsealed areas should be carefully sealed with at least one coat of proprietary wood primer complying with BS 7956-2000 or EN927-1, or one coat of polyurethane or acrylic varnish.

- **Fixing with nails:** When using nails for fixing, they should be punched in below the surface and not inserted nearer than 12mm from any edge. Fix at maximum 900mm centres. For nailing through a moulded profile, lost head pins are recommended.
- **Fixing with adhesive:** Most modern glues and panel adhesives work well, but manufacturers' recommendations should be followed in cases of porous damp surfaces.
- **Fixing of door linings:** It is helpful, but not essential, to drill prior to fixing. Linings should be fixed at maximum 600mm centres.
- **Fixing of door hinges:** Must be fixed with parallel shank screws.

Any visible nail or counter-sunk screw fixings should be filled using a good quality shrink-resistant non-water-based filler. Filled area should then be sanded smooth with a fine abrasive paper (grit range 350-600) prior to painting.

After lightly abrading the surface, primed SAM MDF mouldings are ready to receive a topcoat. Dark colours may require an additional undercoat, but a single topcoat applied with a well-loaded brush will generally achieve a superior finish.

## SAM<sup>®</sup> WRAP

### Wood Veneer / PVC

We recommend that you don't fix SAM MDF mouldings to damp plaster or any other damp materials. SAM wrapped MDF mouldings are easy to fix using traditional tools and materials. Before being fixed in place, all cut or unsealed areas should be carefully sealed with at least one coat of proprietary wood primer complying with BS 7956-2000 or EN927-1, or one coat of polyurethane or acrylic varnish. When cutting or mitring wrapped product, use a fine tooth saw and cut from moulded face into the profile to avoid excessive rough edges and fibres occurring on the visible surface.

- **Fixing with adhesive:** we recommend the use of adhesives when fixing SAM Wrap mouldings and most modern glues and panel adhesives will work well, but manufacturers' recommendations should be followed. Caution is advised to avoid overspill of adhesive onto the face of the moulding as the veneer could be stained.
- **Fixing with nails:** If using nails for fixing, they should be punched in below the surface and not inserted nearer than 12mm from any edge. Fix at maximum 900mm centres. For nailing through a moulded profile, lost head pins are recommended and caution is advised to avoid danger of surface damage when nailing.
- **Fixing of door linings:** For door framing, it is helpful but not essential to drill a pilot hole prior to fixing. Linings should be fixed at a maximum of 600mm centres.

Any visible nail or counter-sunk screw fixings should be filled using good proprietary quality shrink resistant wood filler, suitable for the wood species being used. Alternatively, solid wood plugs (again matching the wood species) may be used. The filled area should then be sanded smooth with a fine abrasive paper (grit range 320-600) prior to staining / finishing.

When varnishing or staining, check with a finish manufacturer for suitability. Before coating the entire surface, it is recommended to perform a colour match test on an "off cut" piece of MDF. If unsure, test a small area before coating entire surface. Polyurethane or an acrylic wood stain varnish / lacquer are a good choice when finishing your SAM Wrap mouldings as they have an excellent moisture and vapour resistance. Water-based acrylic stains should be applied in light coats to avoid overloading the surface with water/ moisture and causing fibre raise.

**Please note, when varnishing or lacquering, the veneered surface may darken substantially in colour.**



**SAM**<sup>®</sup>**ZERO**

### Fully finished

We recommend that you don't fix SAM MDF mouldings to damp plaster or any other damp materials. SAM fully finished MDF mouldings are easy to fix using traditional tools and materials. Before being fixed in place, all cut or unsealed areas should be carefully sealed with at least one coat of proprietary wood primer complying with BS 7956-2000 or EN927-1, or one coat of polyurethane or acrylic varnish. When cutting or mitring fully finished product, use a fine tooth saw and cut from moulded face into the profile to avoid excessive rough edges and fibres occurring on the visible surface.

- **Fixing with adhesive:** SAM recommends the use of instant grab adhesives, but manufacturers' recommendations should be followed in cases of porous, damp surfaces. Caution is advised to avoid overspill of adhesive onto the face of the moulding as the gloss finish could be impaired.
- **Fixing with nails:** If using nails for fixing, they should be punched in below the surface and not inserted nearer than 12mm from any edge. Fix at maximum 900mm centres. For nailing through a moulded profile, lost head pins are recommended, and caution is advised to avoid danger of surface damage when nailing.
- **Fixing of door linings:** For door framing, it is helpful but not essential to drill prior to fixing. Linings should be fixed at maximum 600mm centres with fixings hidden behind the door stop where possible.

Any visible nail or counter-sunk screw fixings should be filled using an appropriate acrylic filler/instant grab/multi-use adhesive. It is advisable that adhesive/filler is applied to the mitred faces prior to fixing to the wall and excess removed from good face as per manufacturing guidelines.

If you need to recoat SAM Zero fully finished mouldings due to impaired surface damage after installation or general wear and tear, you can use a good quality filler and sand them smooth as per manufacturer guidelines. The mouldings surface can be sanded using a 400-grit sandpaper and recoated using any water-based satin/gloss topcoat product available from your local builders' merchant or DIY store. The colour code for SAM Zero fully finished products is RAL 9003 (UK & Ireland) or RAL 9010 (Netherlands, Belgium, France, Germany and Scandinavia).

**SAM**<sup>®</sup>**EXTREME**

### Exterior grade

There are multiple options for fixing SAM Extreme fascia, soffit and cladding. Please refer to the technical guide available for download on the SAM website.

You can download all of our technical guides on the SAM website.



[www.samonline.co.uk](http://www.samonline.co.uk)

# Safety Instructions

---



## Your safety matters

Please ensure you take the following safety precautions when working with MDF.

- Use dust control equipment when sawing, cutting, or drilling SAM MDF mouldings
- Work in a well-ventilated area
- Prevent excessive build-up of dust and maintain good housekeeping
- Keep MDF dust away from ignition sources
- When ventilation is inadequate or impractical, wear face mask and eye protection as detailed below:
  - Disposable/Half Filter Facemask FFP3
  - Eye protection to BS EN 166 9B

## First Aid +

- If you have inhaled wood dust, please move to fresh air and clean nasal passages
- If you have eye contamination from wood dust, please flush with tepid water for 15 minutes.



# SAM<sup>®</sup>

HOME OF MDF MOULDINGS

YOUR SAM DISTRIBUTOR IS:



**SAM Antrim**

Newpark Industrial Estate,  
Greystone Road,  
Antrim,  
Northern Ireland,  
BT41 2RU

Company Reg: NI24953  
VAT No: GB516777223

**SAM Donington**

Mill Lane,  
Donington,  
Spalding,  
PE11 4TL

T: +44(0)28 9442 8288  
E: [team@samonline.co.uk](mailto:team@samonline.co.uk)  
W: [www.samonline.co.uk](http://www.samonline.co.uk)



Scan the QR code  
to view digital copies  
of our brochures

